

*ECS 2001 Joint International Meeting, San Francisco Sept. 2-7, 2001
Sixth International Symposium on Quantum Confinement*

Quantum Devices and Integrated Circuits Based on Quantum Confinement in III-V Nanowire Networks Controlled by Nano-Schottky Gates

Hideki Hasegawa

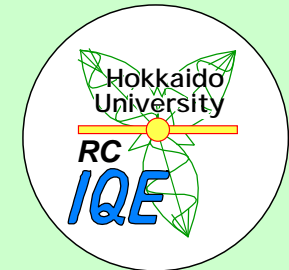

*Research Center for Integrated Quantum Electronics (RCIQE) and
Graduate School of Electronics and Information Engineering
Hokkaido University, Japan*

Outline

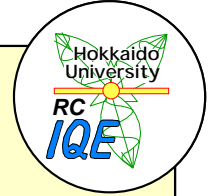

1. *Introduction*
2. *Hexagonal BDD Quantum Circuits*
3. *GaAs-Based Quantum BDD Node Devices and Circuits*
 - *Novel nanometer-scale Schottky gates*
 - *GaAs-based quantum BDD node devices*
 - *Integration of BDD node devices on hexagonal nanowire networks*
4. *Toward Room Temperature Operation and High Density Integration*
 - *Formation of InP-based high density hexagonal nanowire networks*
 - *Surface related key issue*
5. *Conclusion*

Collaborators

RCIQE staff

Dr. S. Kasai, Dr. C. Jiang and Dr. T. Sato

Students

T. Muranaka, A. Ito and M. Yumoto

Speed, Delay-Power Product of Quantum Devices

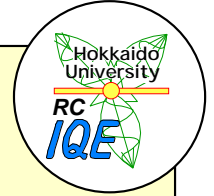

$$= \frac{C}{G} \quad G \quad G_0 \quad \frac{2e^2}{h}$$

J.E.Mooij, 1993 SSDM Ext. Abs. 339

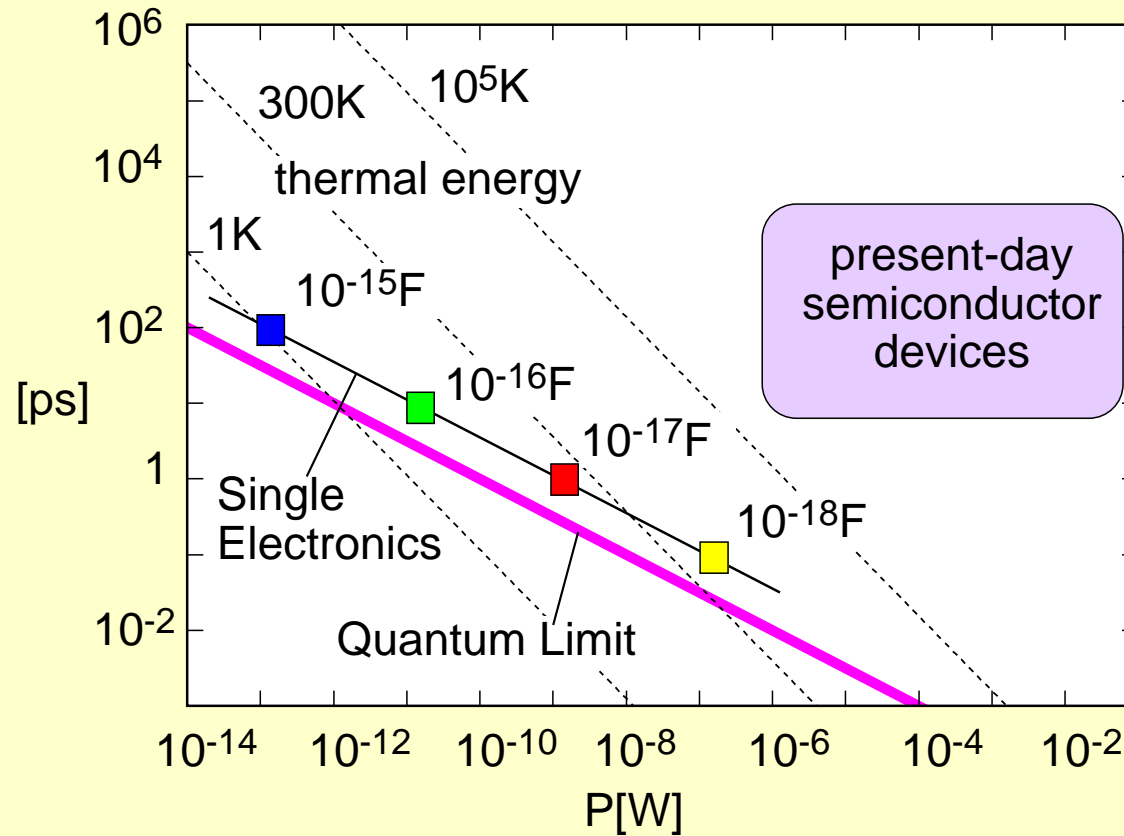

Scale-down limit of
Si CMOS LSIs



Growing demands on
Information Technology (IT)



Research on
Semiconductor Nanostructure



Nanotechnology in wide area
~ chemistry, biology, etc.



***Semiconductor Nanoelectronics
based on Quantum Device and Circuit***

- delay-power product near quantum limit
- small-size and high-density
- nano-sensing, nano-control

But, How to ? So far no realistic approach.

High Density Integration ?

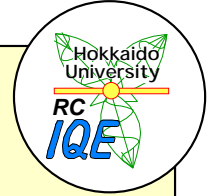

Semi-classical devices

First Monolithic Integrated Circuit in the World (Noyce, 1959)

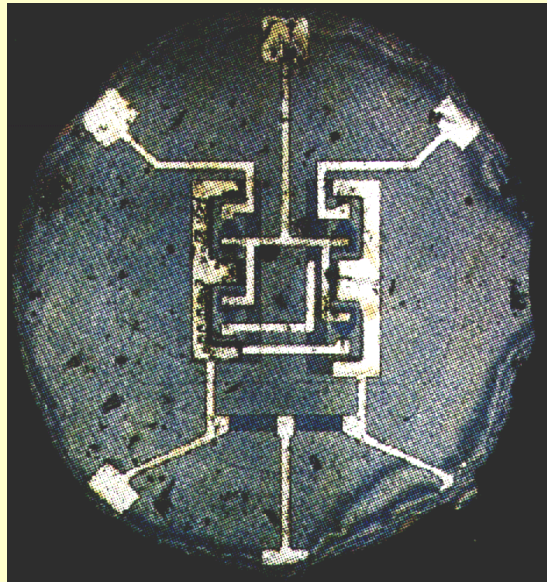

300µm rule

Current Microprocessor (2001)

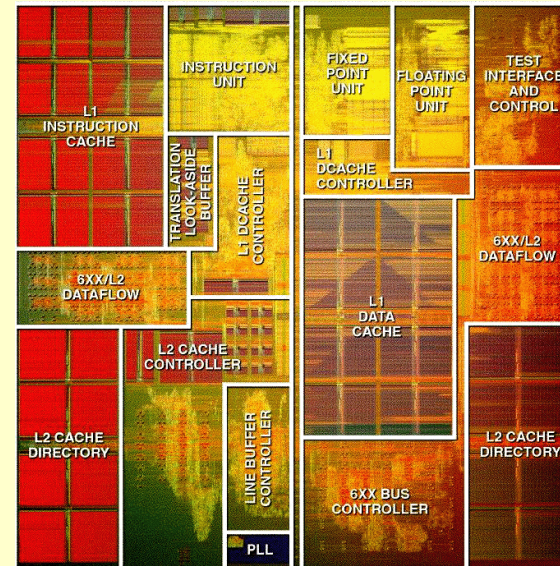

IBM PowerPC

64-bit
0.18µm rule
700MHz
1.4mm x 1.4mm
SOI technology

Discrete quantum devices



How to make QLSIs ?

Example of Quantum Logic Circuits

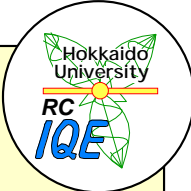

QWRTr-load SET inverter

(S. Kasai and H. Hasegawa presented at DRC 2000)

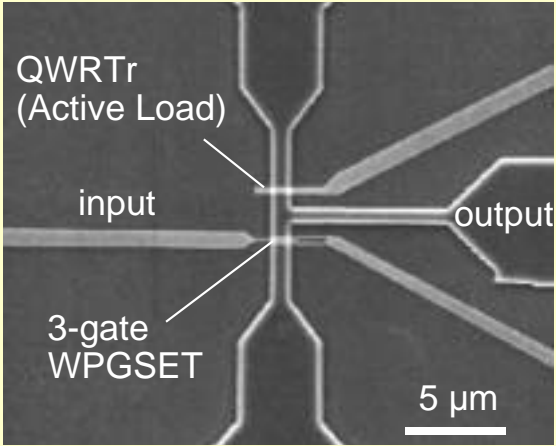

W = 440 nm
 SET: $L_G = 50$ nm, $d_f = 200$ nm
 QWRTr: $L_G = 300$ nm

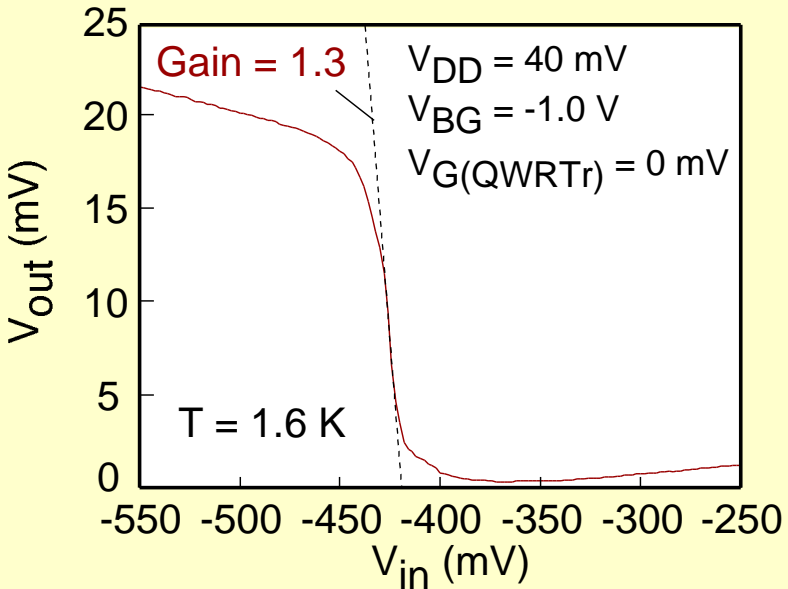
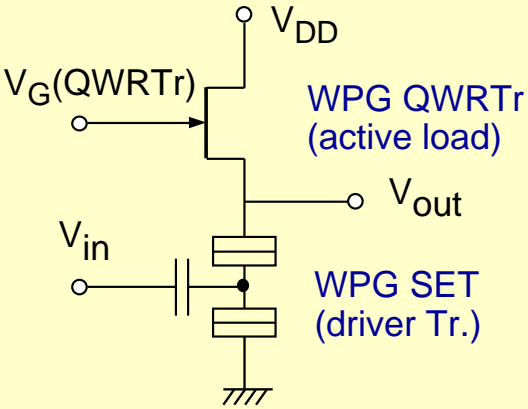

small delay • power product
 but [*low gain*
 voltage mismatch
 poor V_{th} control
 poor drivability
 low temperature

Novel Approach for III-V QLSI

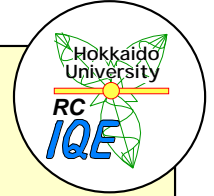

1. Digital Processing Architecture

Binary Decision Diagram (BDD) logic architecture

2. Nanostucture

*Hexagonal nanowire networks by
GaAs etched nanowires and
InGaAs nanowires by Selective MBE*

3. Nanoscale Gate Technology

Schottky in-plane gate (IPG) and wrap gate (WPG)

4. Surface and Interface Control

*Nano-Schottky interface
Interface control layer (ICL)-based passivation*

5. Device

*BDD node devices using gate-control
quantum wire (QWR) and quantum dot (QD)*

Digital Logic Architecture

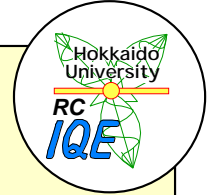

Digital processing
(operations on digital functions)

Implementation of digital functions

Representation

Boolean Equation

Truth Table

Binary Decision Diagram (BDD)

etc.

Implementation

Binary Logic Gate

**Look-Up Table
using Memory**

BDD Device

Transistor Switch

ROM device

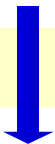
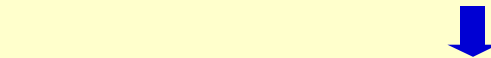

Hexagonal BDD QLSI Approach

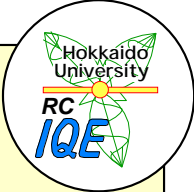

BDD node device

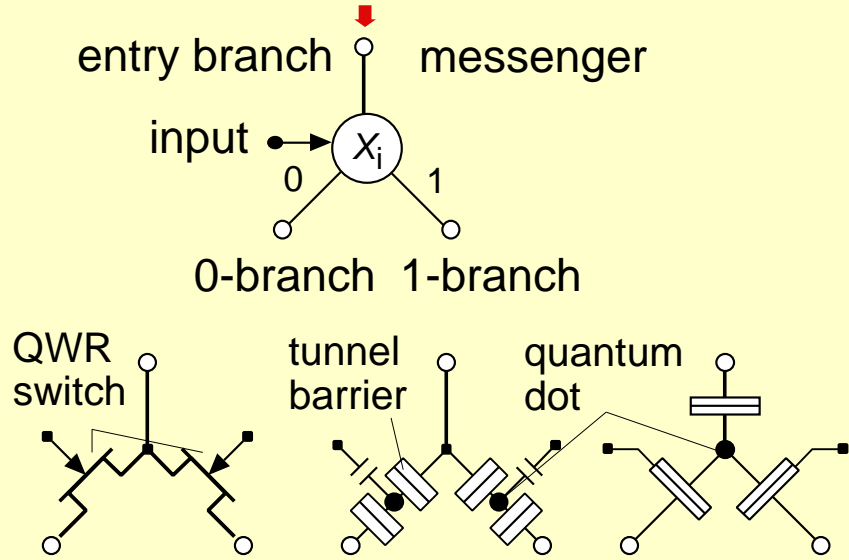

BDD logic architecture

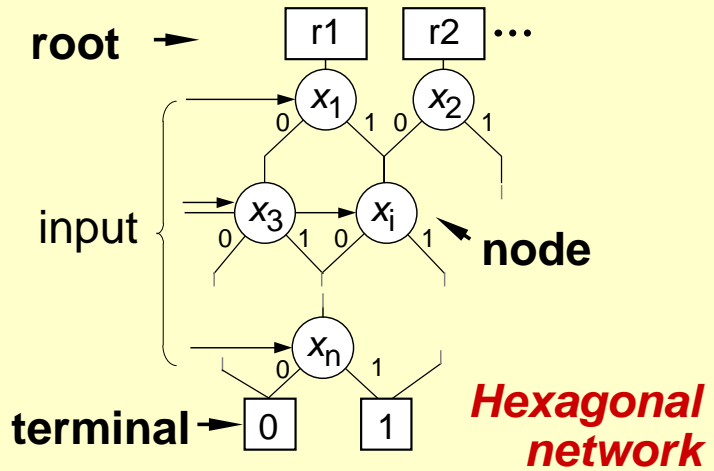

Example: Exclusive OR Logic Function

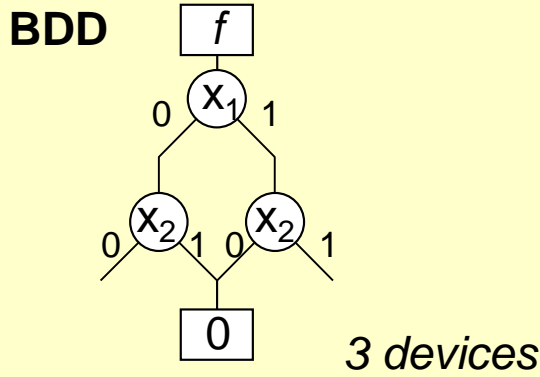

Boolean Logic Gate

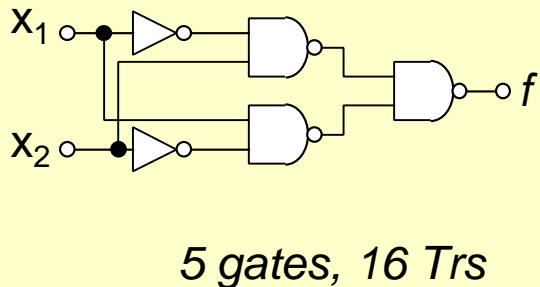

Features of Our Approach

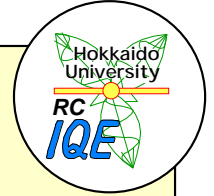

○ BDD is suited to quantum devices

No direct input-output connection is required

- *no precise voltage matching*
- *no large voltage gain*
- *no large current drivability*
- *no large fan-in and fan-out*

○ Ultra-low delay-power product near the quantum limit

○ High density integration

- *hexagonal closely packed nanowire network*
- *free from contact problem*
- *reduced device count*

○ The circuit itself works at room temperature at sacrifice of delay-power product

IPG/WPG QWRTr-based BDD devices act as classical path switching devices even under non-quantum conditions.

Conventional Logic Gate Architecture

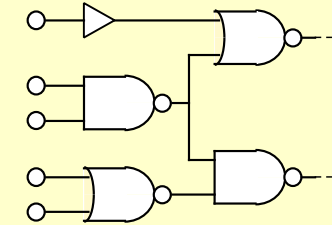

Hexagonal quantum BDD

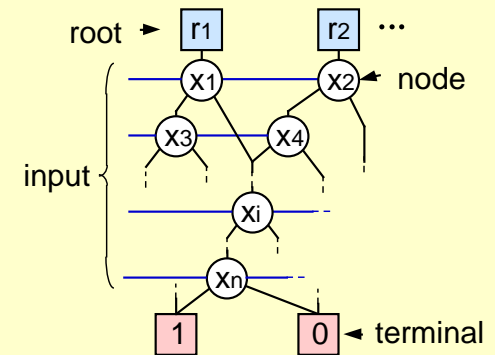

single electron regime



few electron regime



many electron classical regime

Basic Schottky Gate Structure

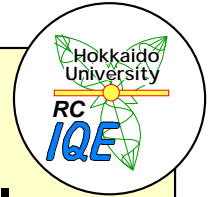

Schottky In-Plane Gate (IPG) and Schottky Wrap Gate (WPG) control of AlGaAs/GaAs etched nanowires

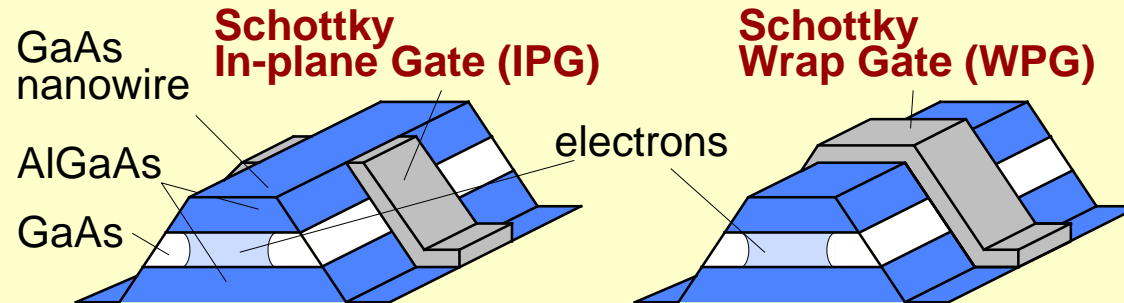

- lateral structure → suitable for planar integration
- stronger confinement size ~ smaller → high temperature operation

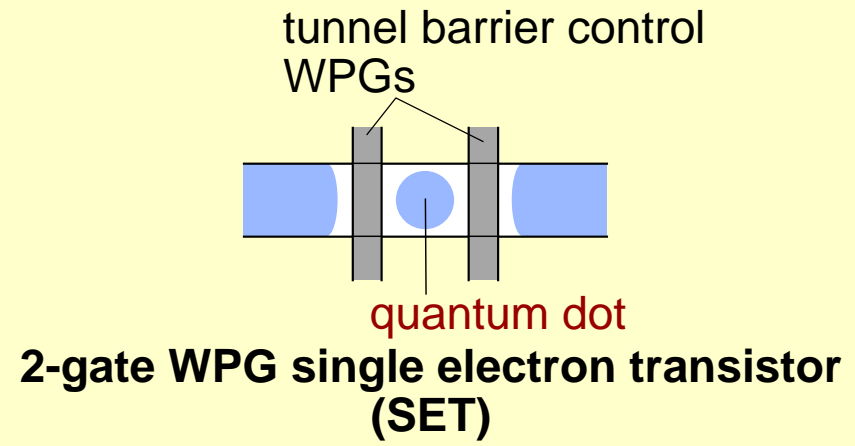
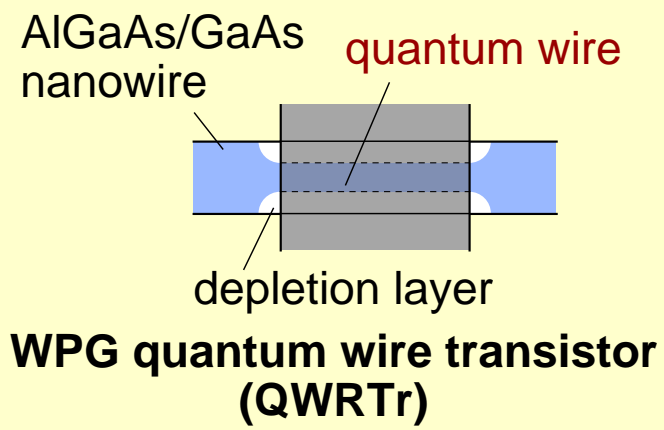

Gate Control Characteristics of IPG/WPG Structures

IPG QWRTr

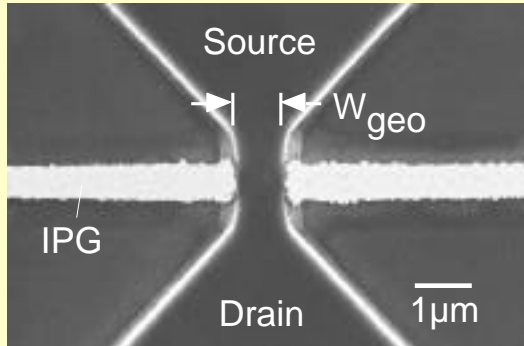

SdH oscillation

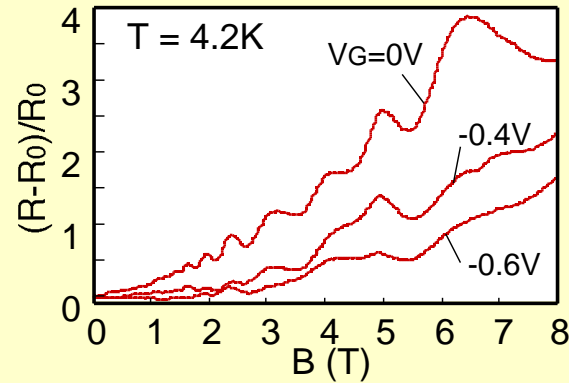

Control of W_{eff}

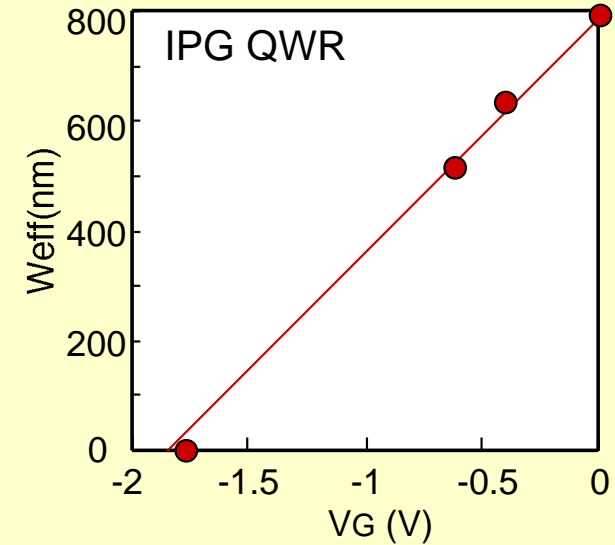

WPG QWRTr

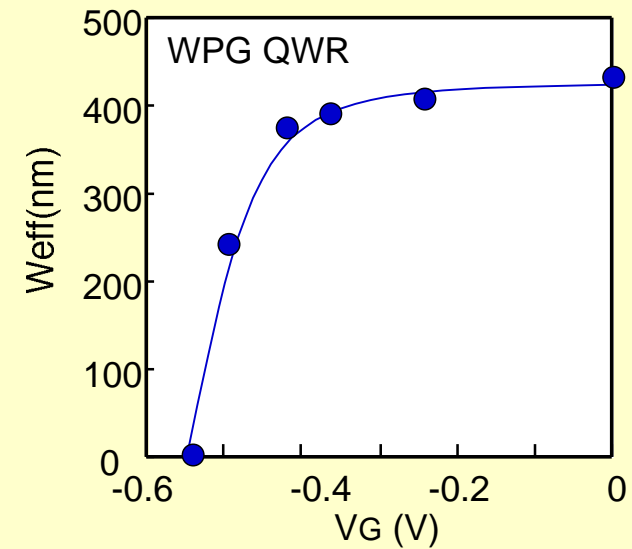
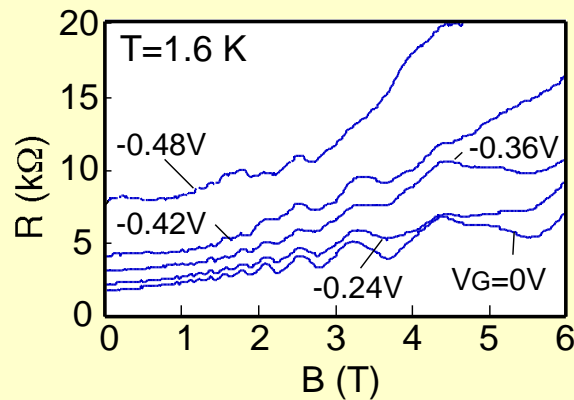
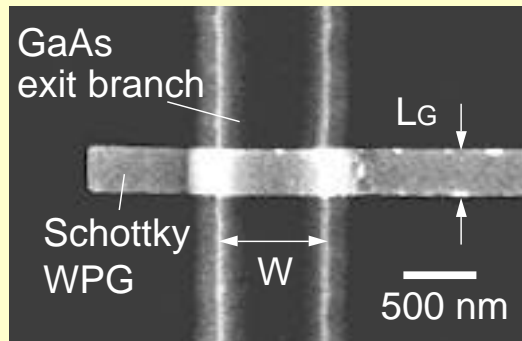

I-V Characteristics of IPG/WPG QWRTrs

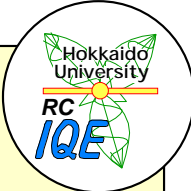

AlGaAs/GaAs etched nanowire

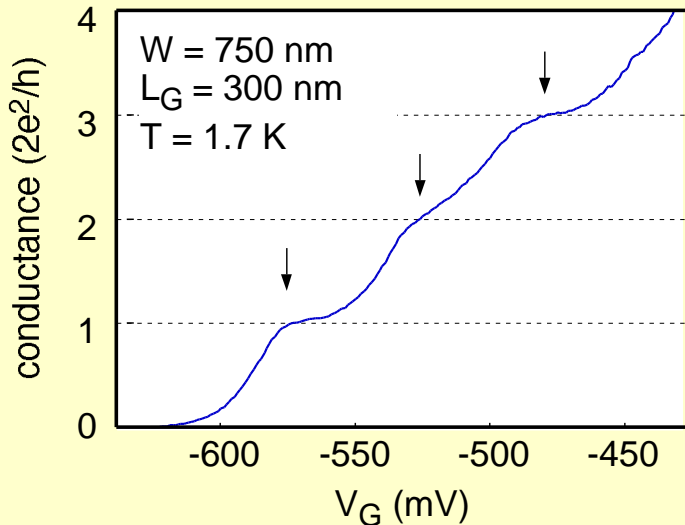
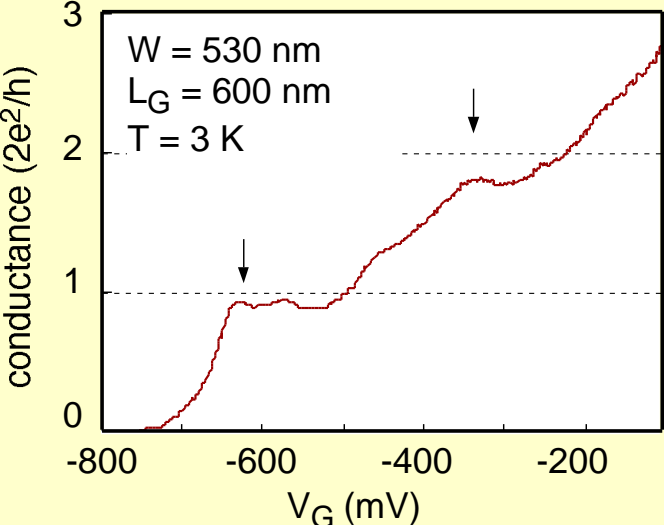
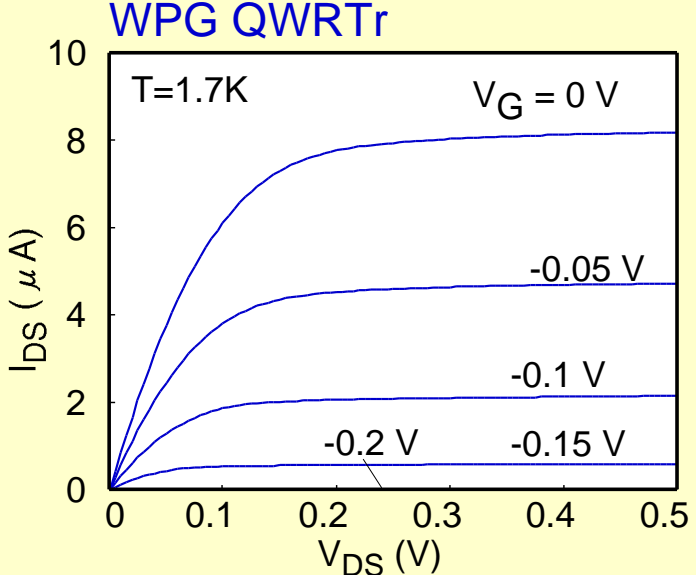
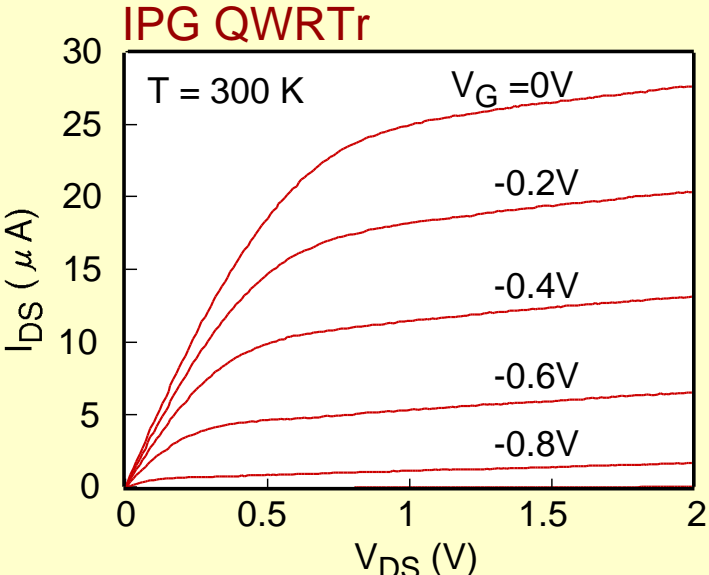

Single Electron Transport in 2-WPG SET

GaAs SET

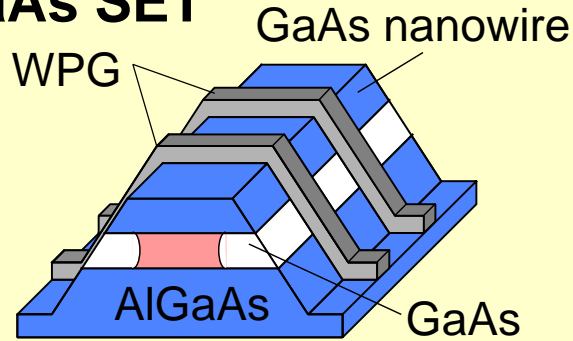

Lateral resonant tunneling of single electron

$$I = -\frac{e^2}{h} \int |T(E)|^2 [f(E) - f(E + qV_{DS})] dE$$

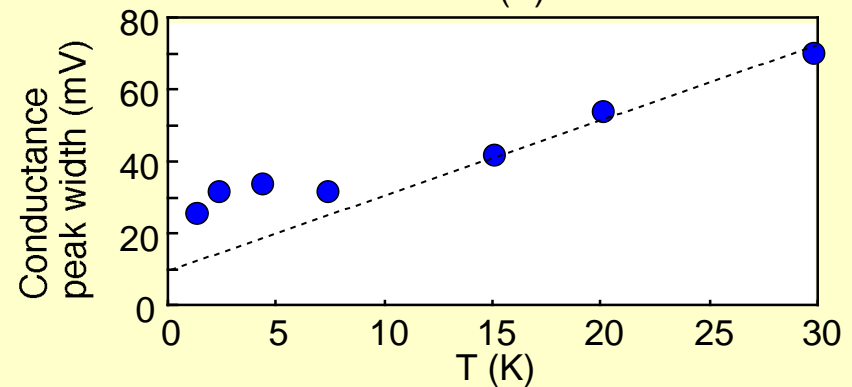
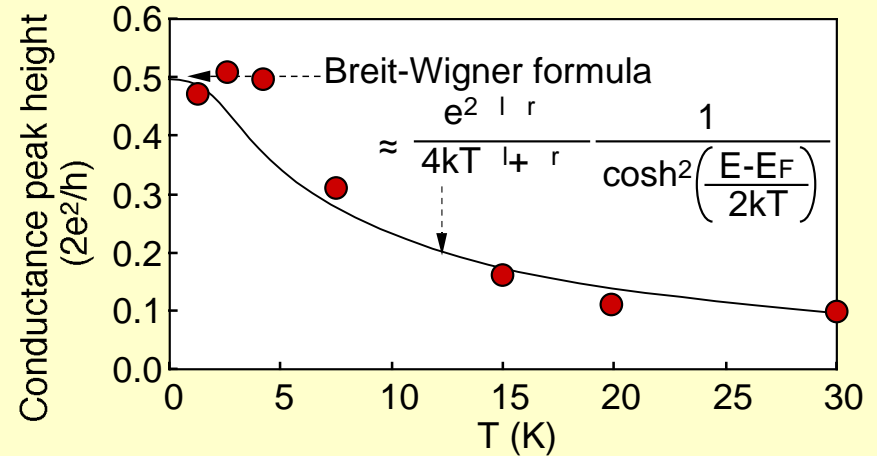
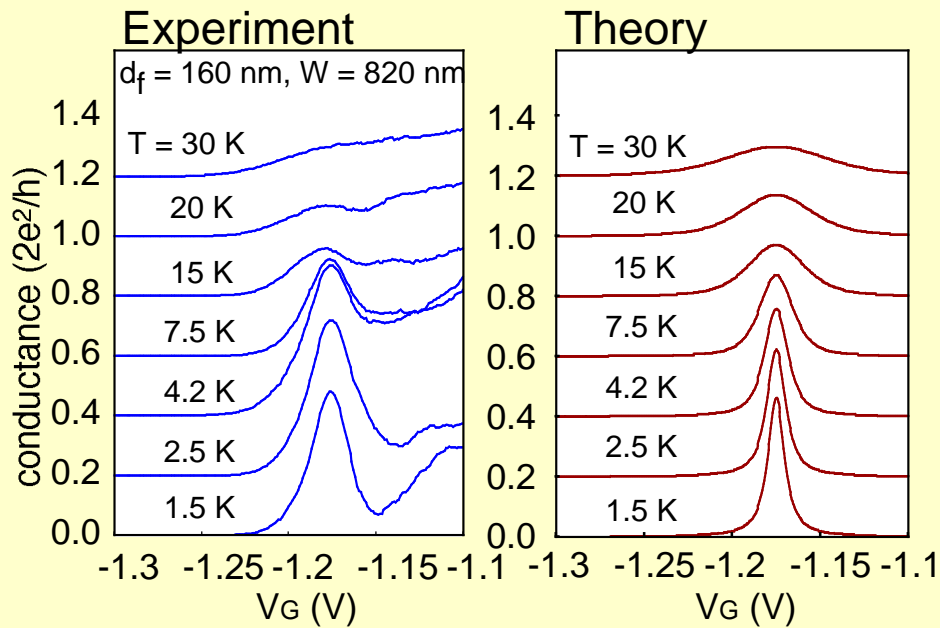

Various Types of BDD Node Devices by IPG/WPG Control of III-V Nanowires

QWR-based BDD node device

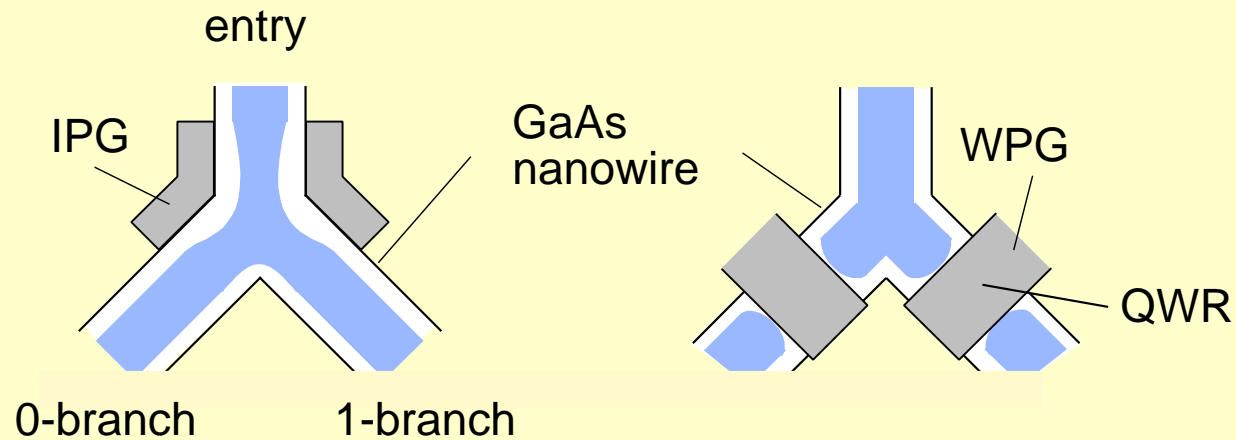

Single electron BDD node device

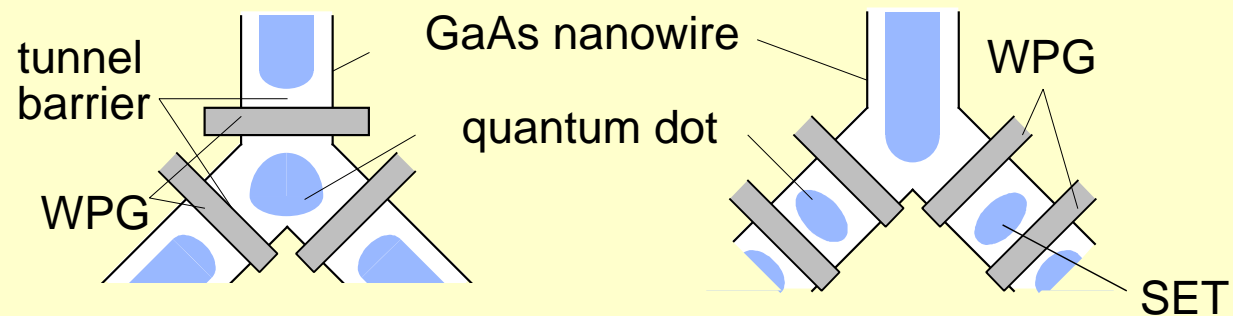

WPG BDD Quantum Node Device

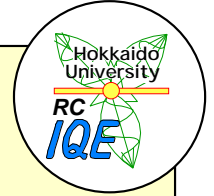

WPG QWR-based BDD device

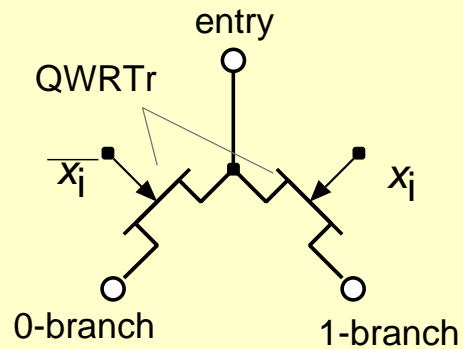
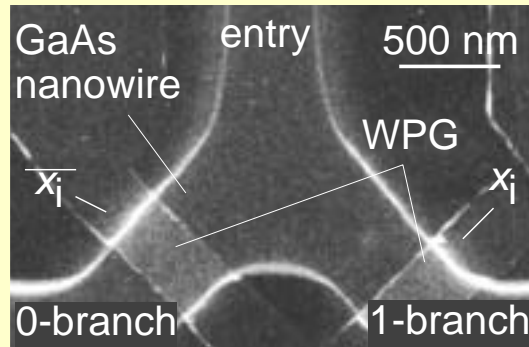

branch switch type

WPG single electron BDD devices

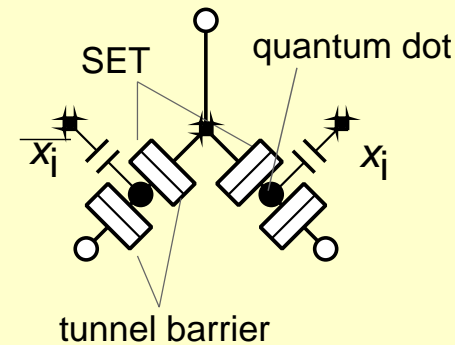
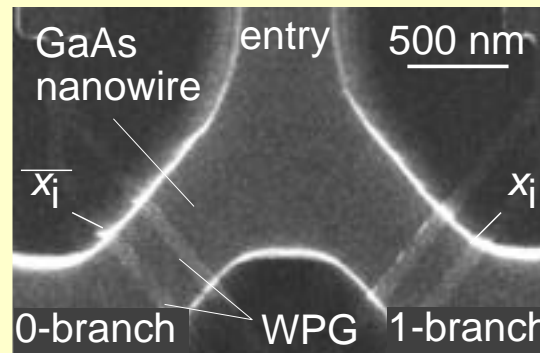

branch switch type

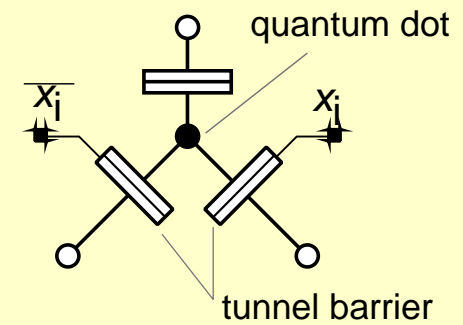
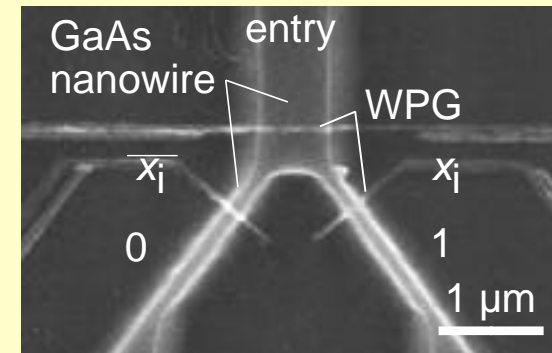

node switch type

Switching Characteristics

QWR branch- switch BDD node device

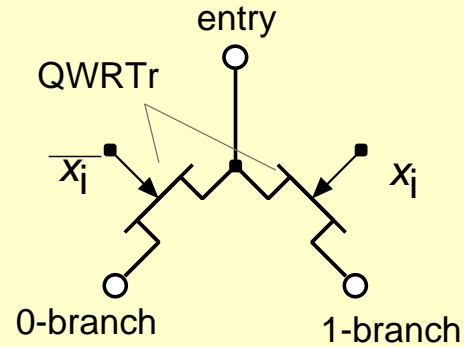

Branch I-V

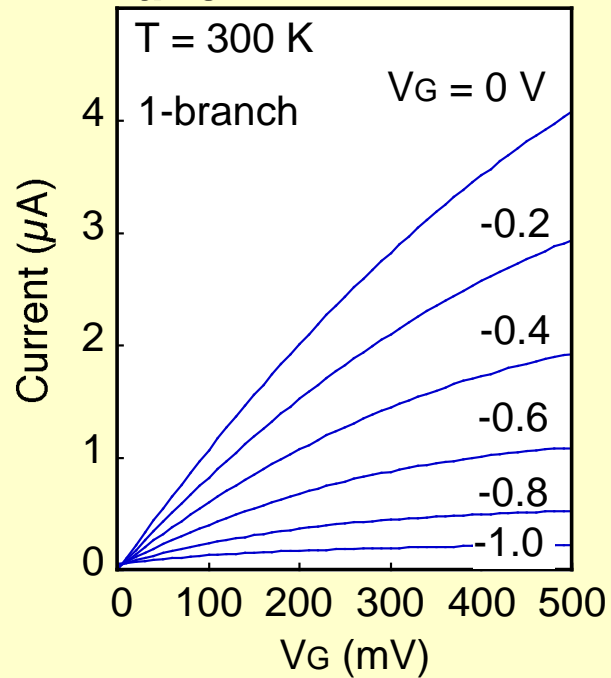

Switching characteristics

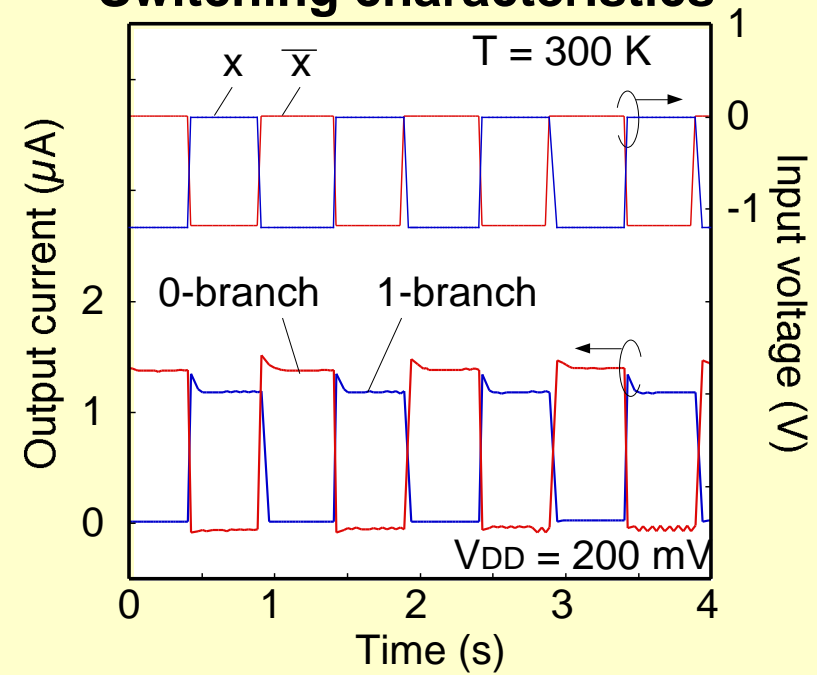

WPG BDD Single Electron Node Device

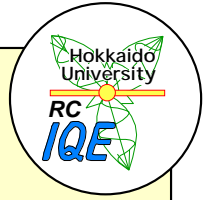

QD-based node switch device

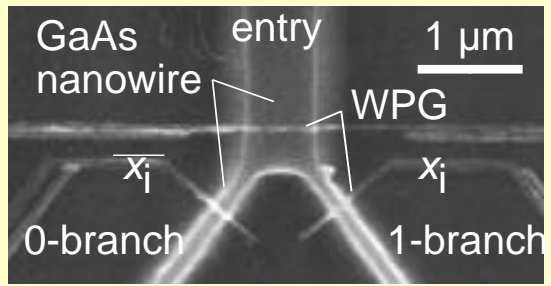

Conductance oscillation from single channel

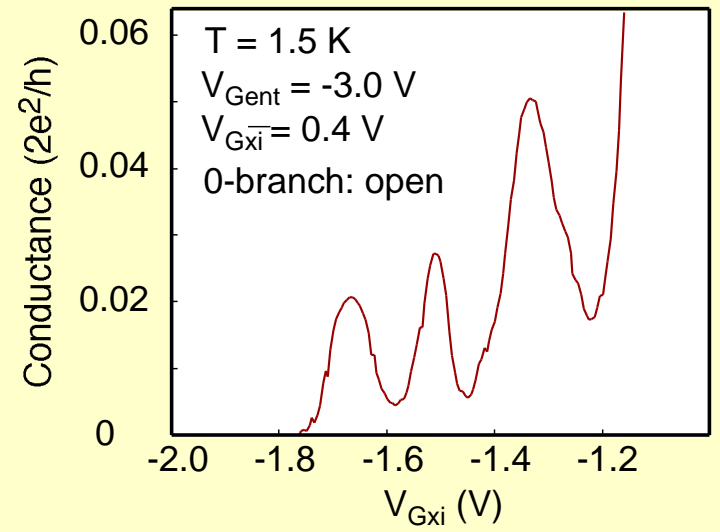

Switching characteristics

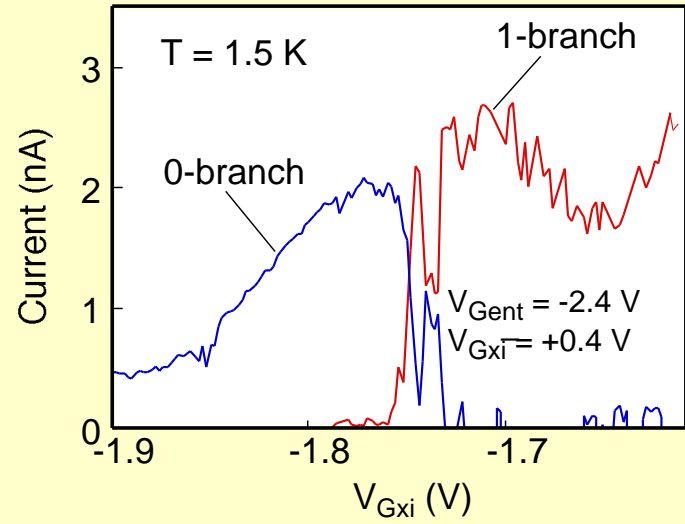

Conductance oscillation due to single electron transport
Clear path switching

Quantum BDD Implementation

Quantum BDD large scale integration

➔ **hexagonal nanowire network + WPG**

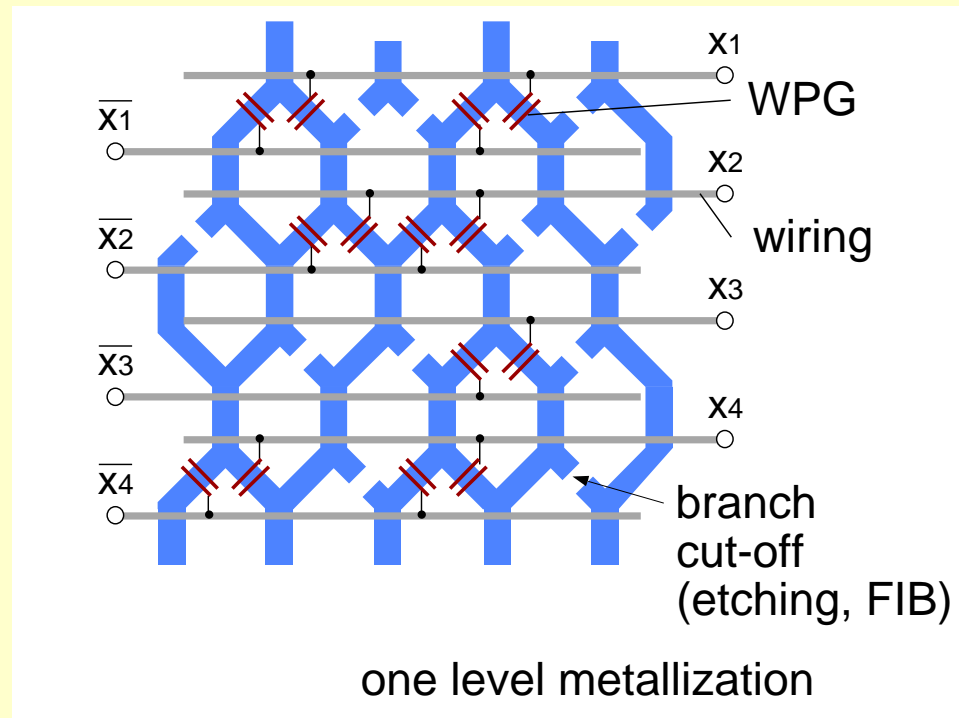
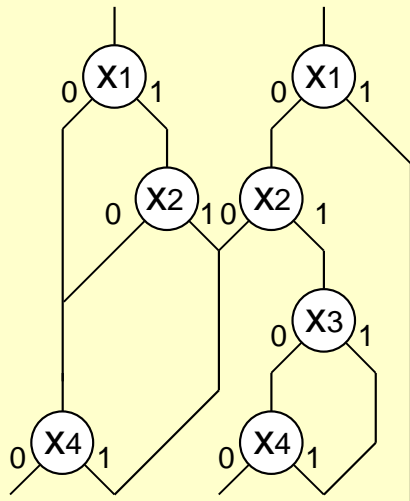

WPG BDD OR Logic Function Block

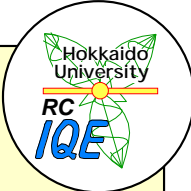

WPG single electron BDD OR circuit

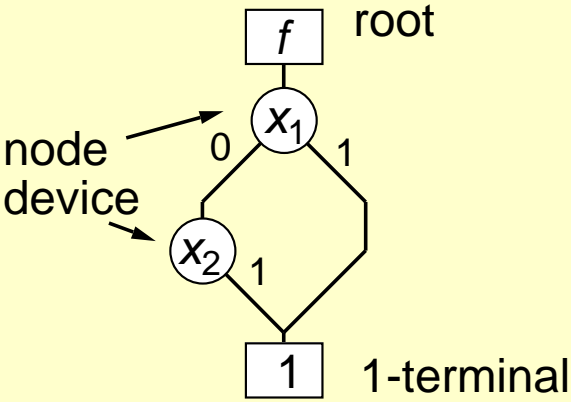
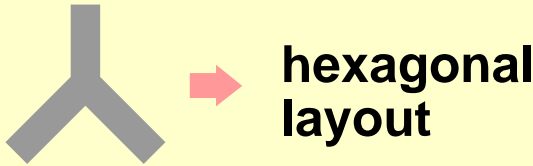
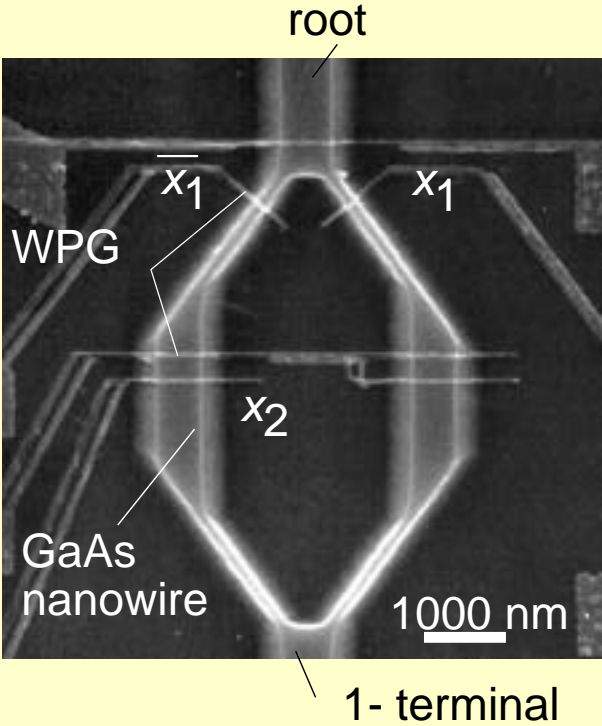

Operation of WPG BDD OR Logic

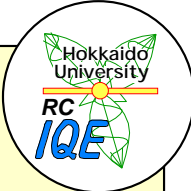

Input/Output waveform

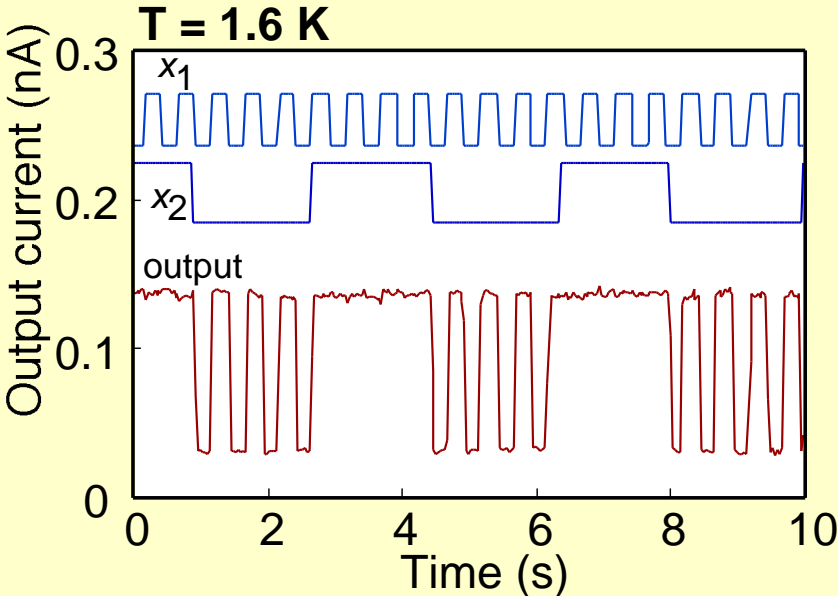
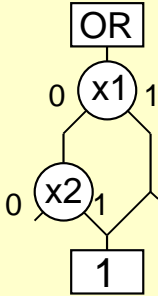

$V_{DD} = 1 \text{ mV}$ pulse height
 clock: 2 Hz x_1 : 100 mV entry gate: 0 mV
 x_2 : 250 mV

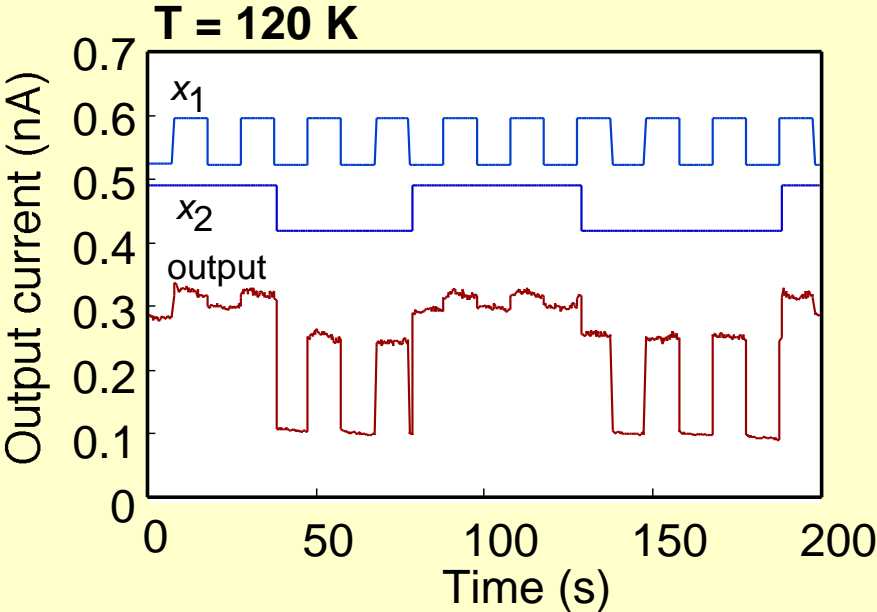

$V_{DD} = 0.2 \text{ mV}$ pulse height
 clock: 0.1 Hz x_1 : 1200 mV entry gate: +1000 mV
 x_2 : 1000 mV

WPG BDD Fundamental Logic Family

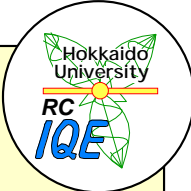

OR

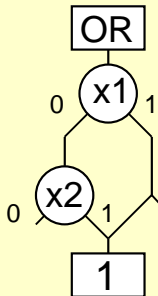

x1	x2	x1+x2
0	0	0
0	1	1
1	0	1
1	1	1

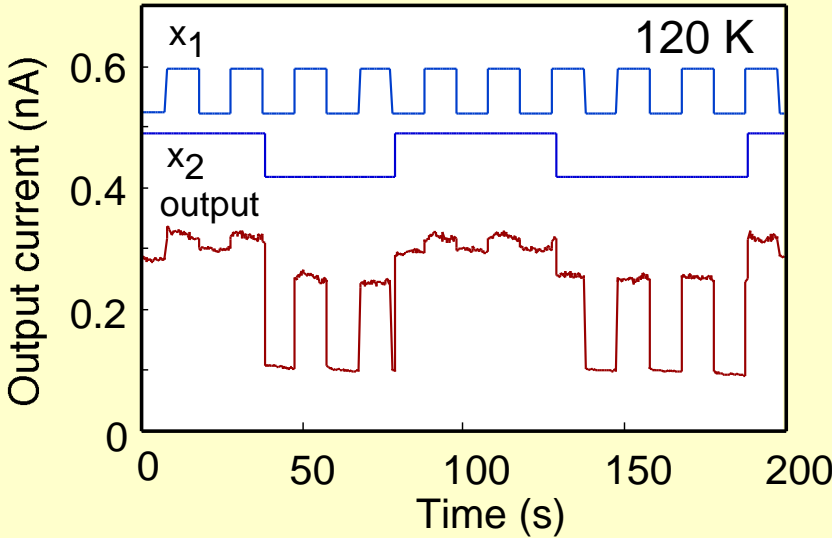

pulse height
 x₁: 1200 mV
 x₂: 1000 mV
 entry gate: +1000 mV
 V_{DD} = 0.2 mV

Half adder (exclusive OR)

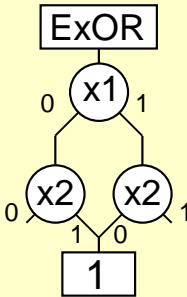

x1	x2	x1⊕x2
0	0	0
0	1	1
1	0	1
1	1	0

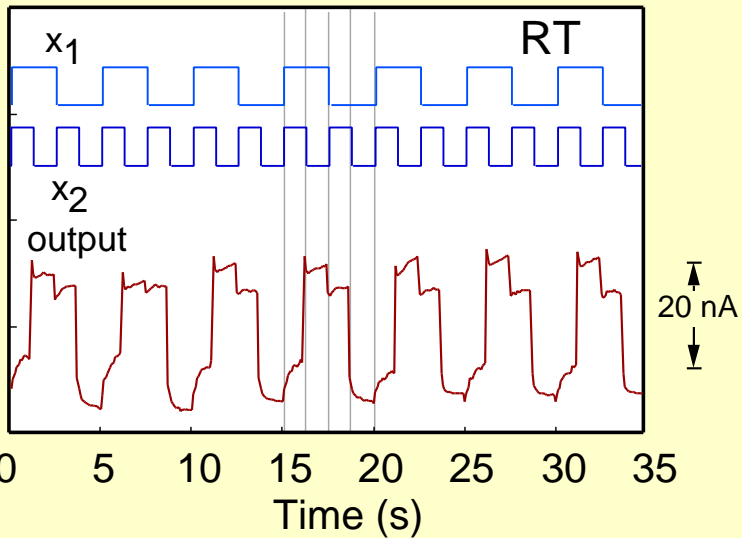

pulse h offset
 +x₁: 0.02 V -0.4 V
 -x₁: 0.44 -1.2
 +x₂: 1.7 1.9
 -x₂: 0.1 1.6
 V_{DD}: 250 mV

Circuit Design and Fabrication Technology Towards BDD Quantum Integrated Circuit

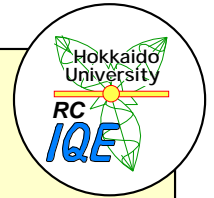

Example: BDD 2-bit adder

circuit diagram

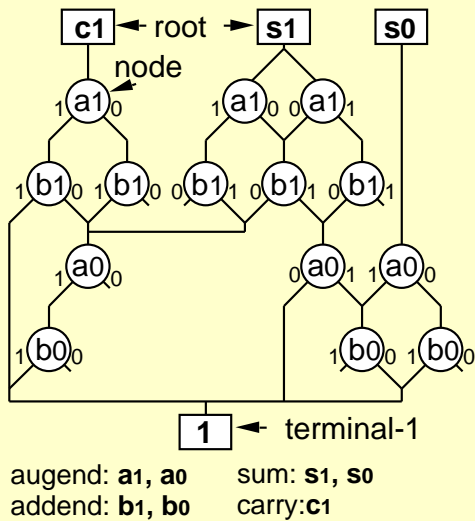

WPG/nanowire layout

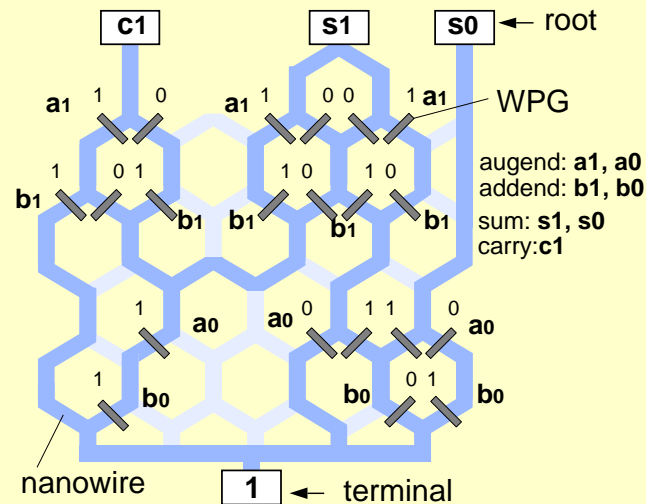

Fabricated 2-bit adder circuit

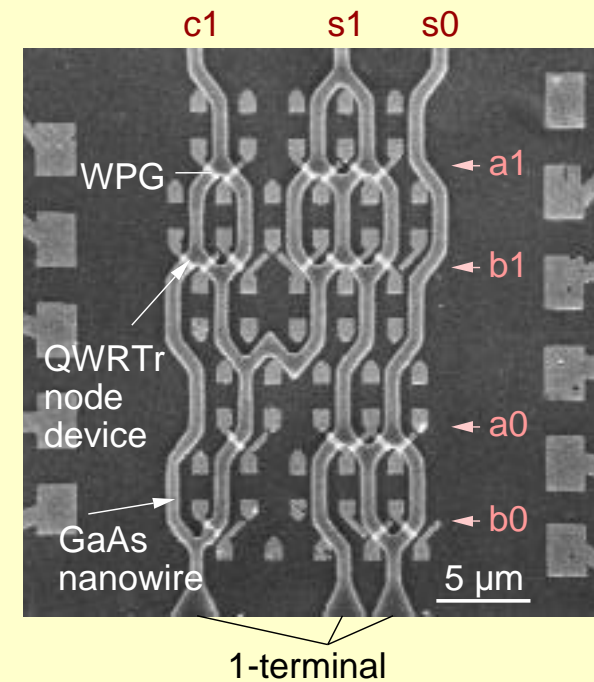

Hexagonal BDD 2 bit Adder

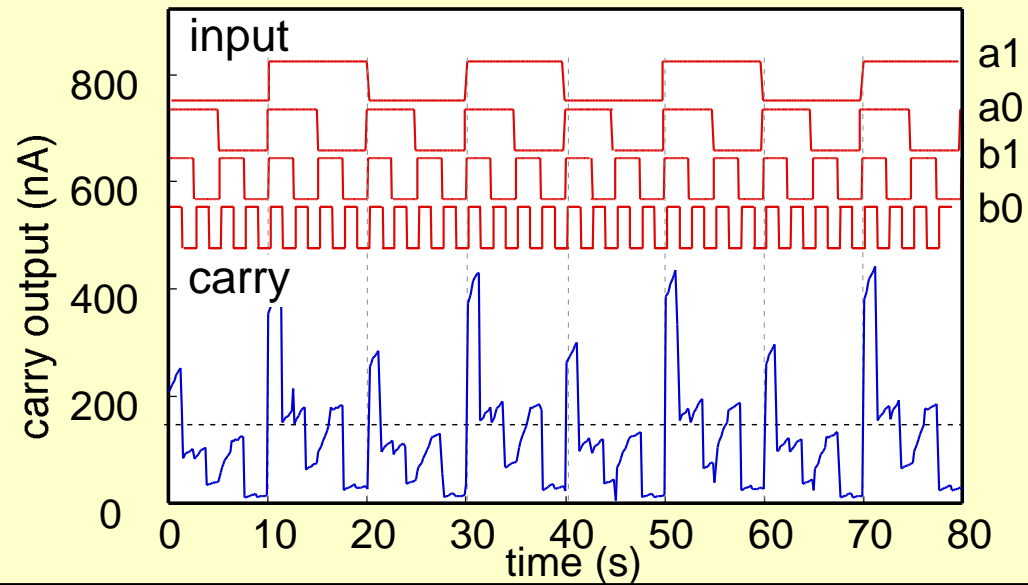
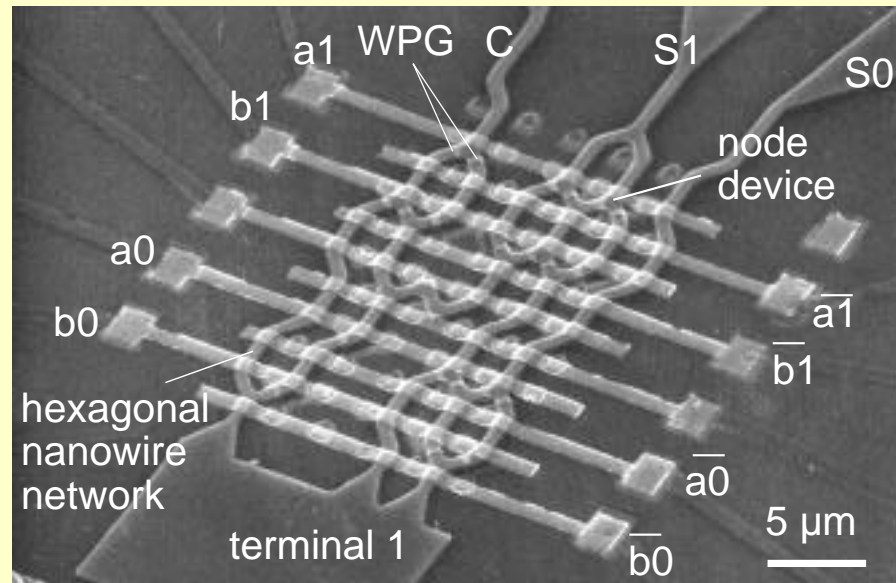

T = 300 K
VDD = 250 mV

InGaAs Ridge Nanowires for Room Temperature Operation

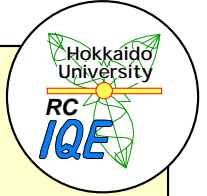

AlGaAs/GaAs etched nanowires:
 possible minimum width = 70-100 nm
 Room temperature operation requires sub-10 nm width

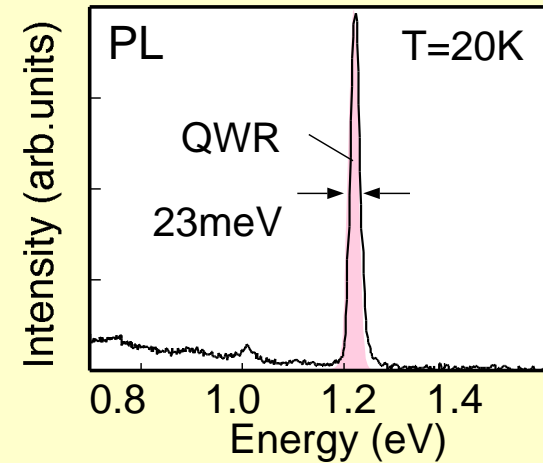
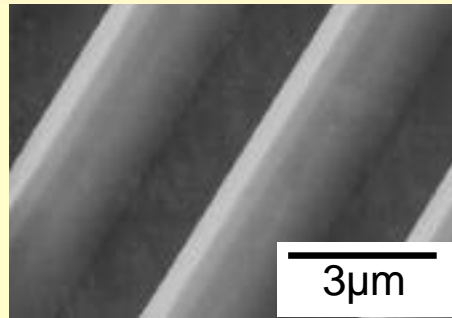
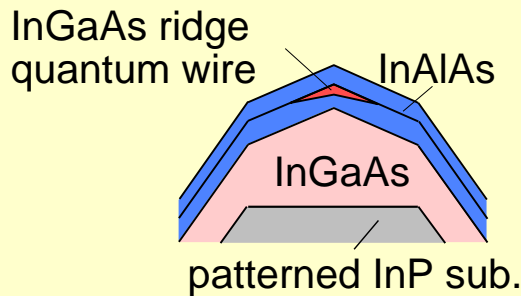

Formation Process

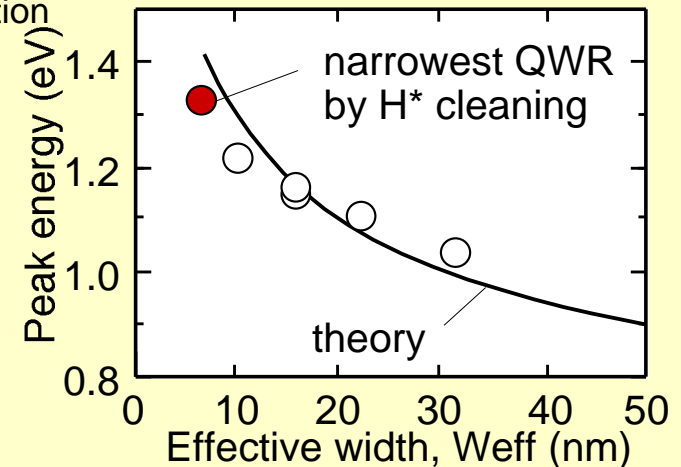
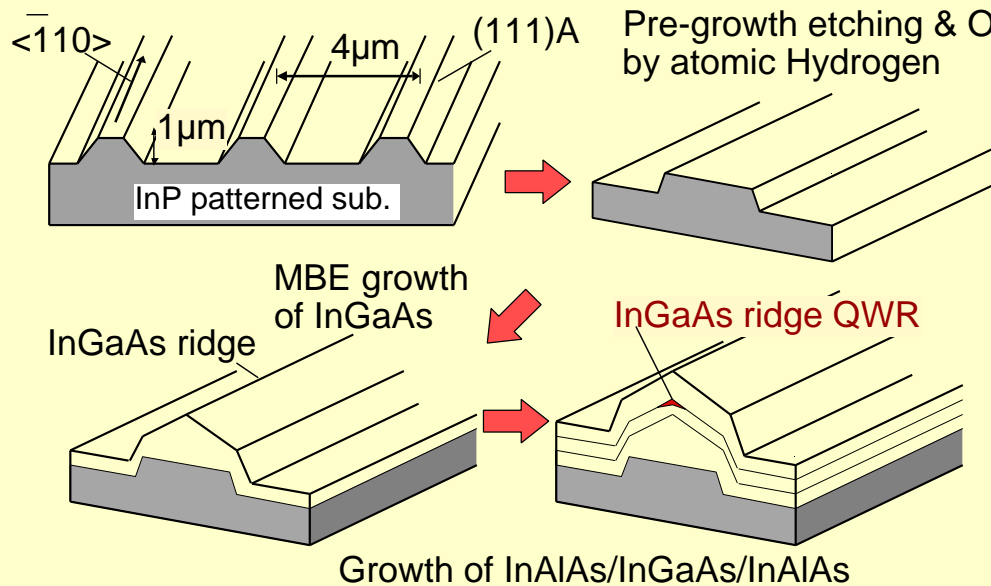

Wire width of 6 nm has been achieved

Hexagonal InGaAs Ridge Nanowire Network

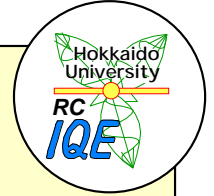

SEM image of hexagonal InGaAs nanowire network

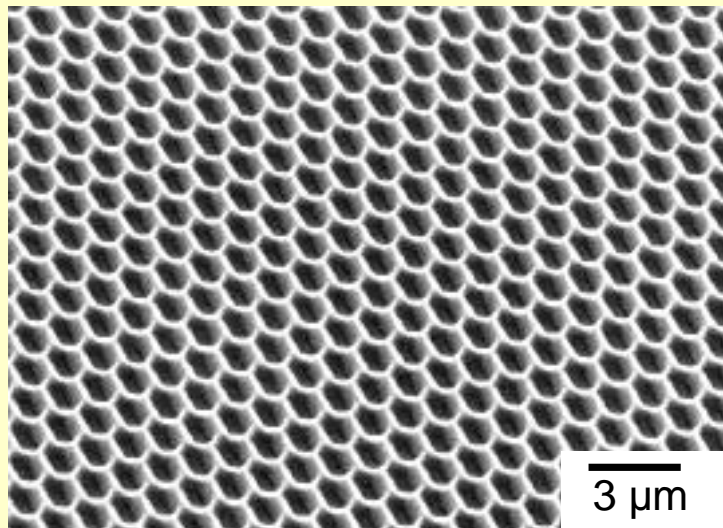

AFM image

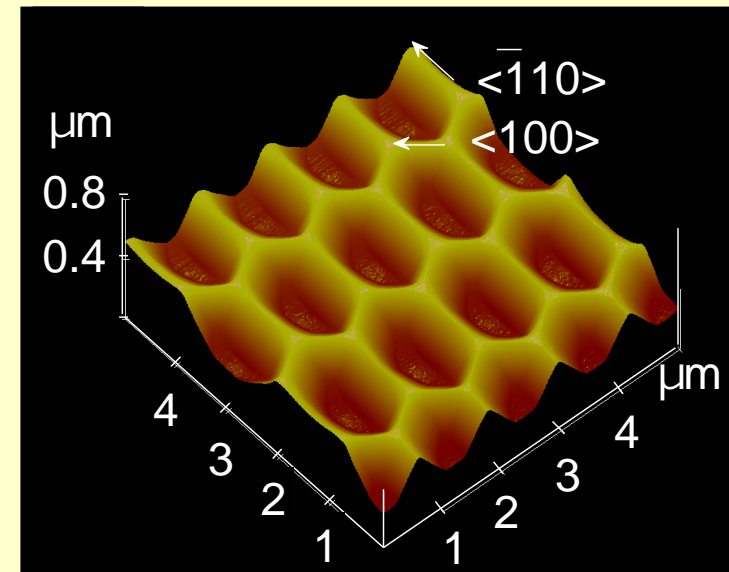

(Ito *et al.* IPRM01, ICFSI-8)

Potential Controllability of Nanometer-Sized Schottky Gates

Semiconductor surface

1. Strong pinning (0.88 eV)
2. Unpinning

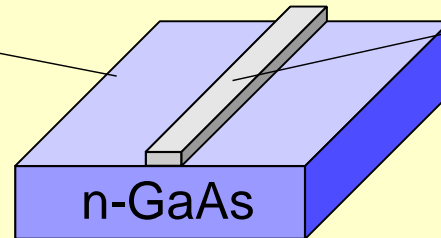

nano-Schottky gate

$$M_S = 1.0 \text{ eV}$$
$$L_g = 90 \text{ nm}$$

1. With strong pinned surface

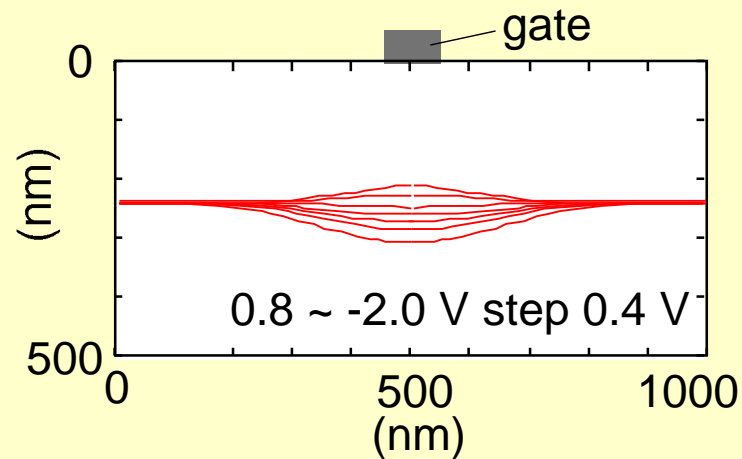

2. With unpinned surface

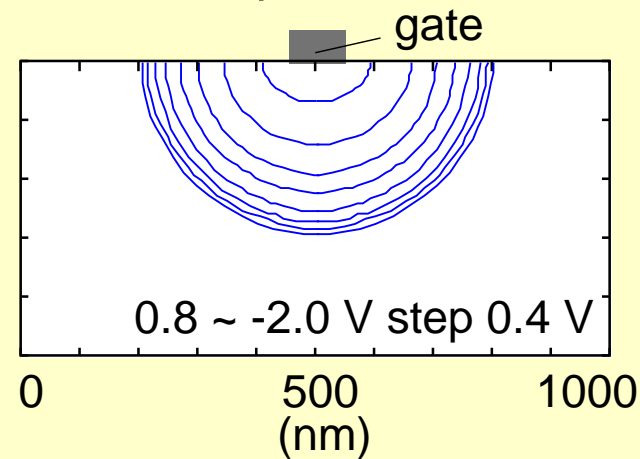

Control of an environmental Fermi level pinning is important

Conclusion

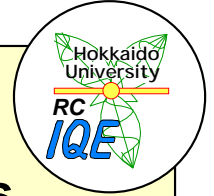

- 1) A new, simple and realistic approach for quantum LSIs is presented and discussed.
 - Architecture: **BDD logic architecture**
 - Hardware: **Schottky WPG control of hexagonal III-V nanowire networks.**
- 2) WPG QWR and single electron BDD node devices using GaAs etched nanowires have been fabricated and BDD switching was realized.
- 3) Hexagonal BDD ICs using GaAs etched nanowires have been fabricated. Logic operation has been confirmed.
- 4) Hexagonal InGaAs nanowire network by H* assisted selective MBE combined with IPG/WPG gate technology gives good prospect for high density BDD QLSIs that are operating at delay-power products near the quantum limit at RT.
- 5) Control of surface/interface remains to be a key issue.