

# Evaluation of numerical results

# Decomposition of binary (MCNC) benchmarks

File	i/o	cost				
		TRADE	MISII	DSGN174	mvgud	[time]
5xpl	7/10	496	384	292	<u>236</u>	[11.0]
9sym	9/1	640	984	400	<u>104</u>	[26.4]
con1	7/2	80	68	<u>60</u>	70	[2.3]
duke2	22/29	6516	2428	<u>2200</u>	2896	[11289.0]
ex5p	8/63	-	3720	<u>1560</u>	2104	[208.0]
f51m	8/8	372	392	240	<u>177</u>	[10.1]
misex1	8/7	472	<u>208</u>	224	229	[8.6]
misex2	25/18	548	464	436	<u>392</u>	[1086.0]
misex3	14/14	9816	4204	3028	<u>1744</u>	[1316.0]
rd53	5/3	120	96	84	<u>60</u>	[1.8]
rd73	7/3	320	352	256	<u>113</u>	[13.1]
rd84	8/4	508	672	320	<u>171</u>	[32.6]
sao2	10/4	1848	516	468	<u>441</u>	[47.2]

Benchmark		Cost for Various Decomposers *								
Name	i(o)	TR	MI	St	SC	LU	Js	Jh	MV	Time, s
5xpl	7/10	496	384	292	288 (9)	288 (9)	320 (20)	336 (21)	<u>236</u>	11.0
9sym	9/1	640	984	400	224 (7)	160 (5)			<u>104</u>	26.4
con1	7/2	80	68	60					<u>70</u>	2.3
duke2	22/29	6516	2428	<u>2200</u>	3456 (108)				2896	11289.0
ex5p	8/63		3720	<u>1560</u>					2104	208.0
f5lm	8/8	372	392	240	256 (8)				<u>177</u>	10.1
misex1	8/7	472	208	224	256 (8)	354 (11)	304 (19)	288 (18)	<u>229</u>	8.6
misex2	25/18	548	464	436	768 (24)				<u>392</u>	1086.0
misex3	14/14	9816	4204	3028					<u>1744</u>	1316.0

Function	in	MBDD in	MBDD nodes	MVDD nodes	MBDD size	MVDD size	Size %
audiology	69	80	7039	6668	28156	34021	82%
breastc	9	36	4093	1119	16372	14547	112%
bridges1	9	16	359	195	1140	1137	100%
bridges2	10	18	503	262	1576	1537	102%
chess1	6	16	7820	3091	31280	33981	92%
chess2	36	37	8802	8446	34900	42538	82%
connect-4	42	84	82639	40724	273252	244344	111%
flag	28	57	6651	3557	26284	25854	101%
house-votes	16	16	407	407	1628	2035	80%
letter	16	64	318883	77004	1275532	1463076	87%
lung-cancer	56	112	2953	1472	11812	10304	114%
programm	12	24	33317	16419	115496	104737	110%
sensory	11	19	1853	1074	6992	6541	106%
sleep	9	31	933	238	3328	3143	105%
sponge	44	86	3472	1745	13888	11987	115%
tic-tac-toe	9	18	779	338	2400	2028	118%
trains	32	51	314	193	1256	1247	100%
alet	18	72	21967	5316	79500	69108	115%
d4	14	29	486	219	1872	1543	121%
d7	24	61	1123	416	4284	3647	117%
d8	32	80	1527	588	5800	4869	119%
d9	34	84	1616	629	6156	5162	119%
d10	37	89	1720	688	6572	5554	118%
geo	11	32	3163	831	11556	8879	130%
ket	18	72	21910	5304	79296	68952	115%
ul	60	153	22552	9839	90208	73631	122%
ul_4	60	91	329	237	1316	1319	99%
ul_5	60	98	437	295	1748	1701	102%
ul_10	60	129	1106	571	4424	3773	117%
u2	60	144	21344	10085	85376	71369	119%
u3	60	151	22363	9831	89452	71898	124%
u4	60	144	21492	9989	85968	70693	121%
u5	60	143	21779	10064	87116	71157	122%
total			645,731	227,854	2,485,936	2,536,120	98%
w/o letter			326,848	150,850	1,210,404	1,073,044	113%

Table 3.2: MVDD and MBDD size comparisons.

filename	in	sol.	Top Down			Jozwiak			pure CI
			random	fifo	CI	random	fifo	CI	
cardiology	69	157	>2000	>2000	>2000	>2000	>2000	>2000	>2000
balance	4	4	0,1	0,1	0,1	0,8	0,8	0,8	0,6
breastc	9	9	92,6	98,9	94,6	92,6	89,7	106,0	234,9
bridges1	9	9	0,4	0,1	0,1	0,7	0,7	0,7	97,1
bridges2	10	10	0,7	0,1	0,1	1,0	1,0	1,0	193,1
car	6	6	0,1	0,1	0,1	0,2	0,2	0,2	3,2
glass	6	6	0,1	0,1	0,1	9,0	9,0	9,1	196,6
glass2	36	29	66,4	49,4	41,7	76,3	76,0	76,6	>2000
glass	6	6	0,1	0,1	0,1	0,4	0,4	0,4	9,8
connect-4	42	347	>2000	>2000	>2000	>2000	>2000	>2000	>2000
employ1	9	9	0,2	0,1	0,1	0,2	0,2	0,2	29,6
employ2	7	7	0,1	0,1	0,1	0,1	0,1	0,1	7,7
flag	28	77	>2000	>2000	>2000	>2000	>2000	>2000	>2000
flags1	10	10	0,7	0,1	0,1	1,4	1,4	1,4	271,4
flags2	10	9	0,1	0,9	0,9	2,4	2,9	2,6	324,2
glass-votes	16	16	0,2	0,1	0,1	1,8	1,9	1,8	>2000
letter	16	157	>2000	>2000	>2000	>2000	>2000	>2000	>2000
lung-cancer	66	47	>2000	>2000	>2000	>2000	>2000	>2000	>2000
monks1tr	6	3	0,1	0,8	0,9	0,1	0,1	0,1	2,7
monks2tr	6	6	0,2	0,1	0,1	0,3	0,3	0,3	6,7
monks3tr	6	4	0,1	0,4	0,6	0,2	0,2	0,2	3,4
monks3svm	22	4	1277,7	644,0	688,0	>2000	>2000	>2000	>2000
post-op	8	8	0,4	0,1	0,1	0,4	0,4	0,4	23,4
programms	12	12	4,3	0,7	0,7	100,3	100,6	97,4	>2000
sensory	11	6	30,9	26,0	36,2	391,0	376,6	600,4	1321,6
spectrom	6	6	0,1	0,1	0,1	0,6	0,6	0,6	1,4
sleep	9	6	17,2	9,3	7,6	9,6	6,1	11,4	168,1
sponge	44	3	>2000	>2000	>2000	1736,2	>2000	>2000	>2000
tic-tac-toe	9	8	1,3	0,4	0,4	212,1	213,3	200,1	260,2
trajins	32	1	14,4	16,6	16,3	23,4	6,2	0,3	0,3
svm	16	6	10,6	10,2	14,9	36,6	44,4	26,6	1001,7
svm1	18	17	24,0	13,7	9,6	8,9	8,9	9,3	>2000
c2a	11	2	1,1	1,4	1,8	3,6	9,2	3,9	3,7
c2b	11	3	4,2	2,9	6,2	6,8	6,6	7,1	7,9
c3a	14	2	6,2	4,3	4,9	7,8	14,9	9,9	9,8
c3b	14	3	12,1	8,6	19,7	13,6	14,4	16,7	16,8
c4a	14	2	6,0	4,2	7,7	12,4	12,7	11,3	11,2
c4b	14	3	12,9	9,6	19,6	13,8	14,0	16,1	16,2
c5a	13	2	4,7	3,8	6,6	4,9	4,7	2,6	2,4
c5b	13	2	4,4	2,0	6,8	1,9	3,6	2,6	2,4
c6a	13	2	6,3	4,6	7,6	3,8	2,1	2,6	2,7
c6b	13	2	6,4	4,9	7,2	2,4	3,3	2,6	2,4
d2	11	4	1,3	1,2	1,4	1,3	1,4	1,6	34,7
d3	14	4	17,8	16,7	24,7	96,1	126,9	97,9	98,4
d4	14	3	19,9	13,2	22,4	29,0	28,3	36,6	36,3
d5	13	2	4,4	4,3	8,1	9,6	18,2	3,9	3,7
d6	13	2	12,2	9,3	14,9	10,7	24,0	6,2	4,6
d7	24	2	184,8	89,4	119,4	129,9	82,2	17,3	17,6
d8	32	2	1279,7	271,4	362,8	126,2	130,1	31,4	31,2
d9	34	2	372,9	343,8	496,1	283,6	199,6	36,2	36,9
d10	37	2	617,1	477,1	616,4	329,6	310,6	41,1	41,2
gso	11	6	67,6	36,3	79,3	166,2	174,4	167,2	1666,2

Top Down  
algorithm  
comparison with  
Jozwiak's  
algorithm.

Function	in	FLASH	SBSD
add0	8	28	28
add2	6	20	20
and_or_chain8	8	28	28
ch22f0	6	20	20
ch30f0	6	32	40
ch47f0	6	60	56
ch52f4	8	180	156
ch70f3	8	40	44
ch74f1	8	72	84
ch83f2	8	116	120
ch8f0	6	32	40
4_ones	8	76	76
greater_than	8	28	28
interval1	8	128	88
interval2	8	92	76
kdd2	5	16	16
kdd3	5	12	12
kdd5	8	32	48
kdd6	8	12	12
kdd7	8	28	28
kdd9	8	20	20
kdd10	6	20	20
majority_gate	8	64	76
monkish1	4	12	12
monkish2	8	60	60
monkish3	5	20	20
max8	6	24	32
or_and_chain8	8	28	28
pal	8	28	28
parity	8	28	28
rnd_m1	8	28	28
rnd_m10	8	80	108
rnd_m25	8	172	180
rnd_m5	8	64	72
rnd_m50	8	224	256
substr1	8	72	72
substr2	8	60	60
subtraction1	8	64	68

**SBSD  
comparison to  
FLASH on  
Wright Lab  
benchmark  
functions.**

# APPLICATIONS

- **FPGA SYNTHESIS**
- **VLSI LAYOUT SYNTHESIS**
- **DATA MINING AND KNOWLEDGE DISCOVERY**
- **MEDICAL DATABASES**
- **EPIDEMIOLOGY**
- **ROBOTICS**
- **FUZZY LOGIC DECOMPOSITION**
- **CONTINUOUS FUNCTION DECOMPOSITION**

# Example of a application

**VLSI Layout**



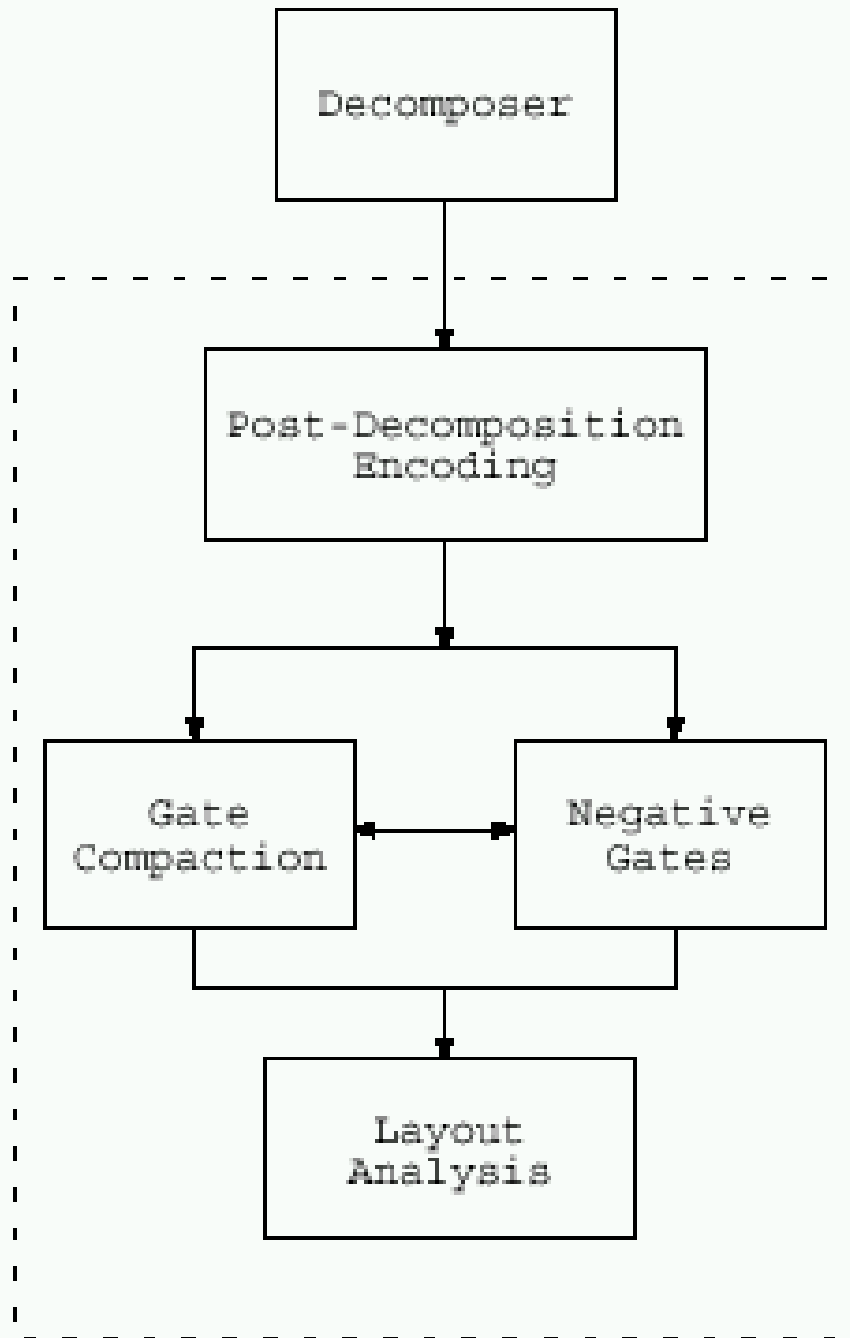

**Layout  
decomposition  
block  
diagram.**

# Number of complex gates with limited serial transistors

		Number of Serial PMOS Transistors				
		1	2	3	4	5
Number of Serial NMOS Transistors	1	1	2	3	4	5
	2	2	7	18	42	90
	3	3	18	87	396	1677
	4	4	42	396	3503	28435
	5	5	90	1677	28435	125803

VLSI layout of  $\bar{f} = d(a + c) + (b + c)(\bar{b}\bar{d})$ .

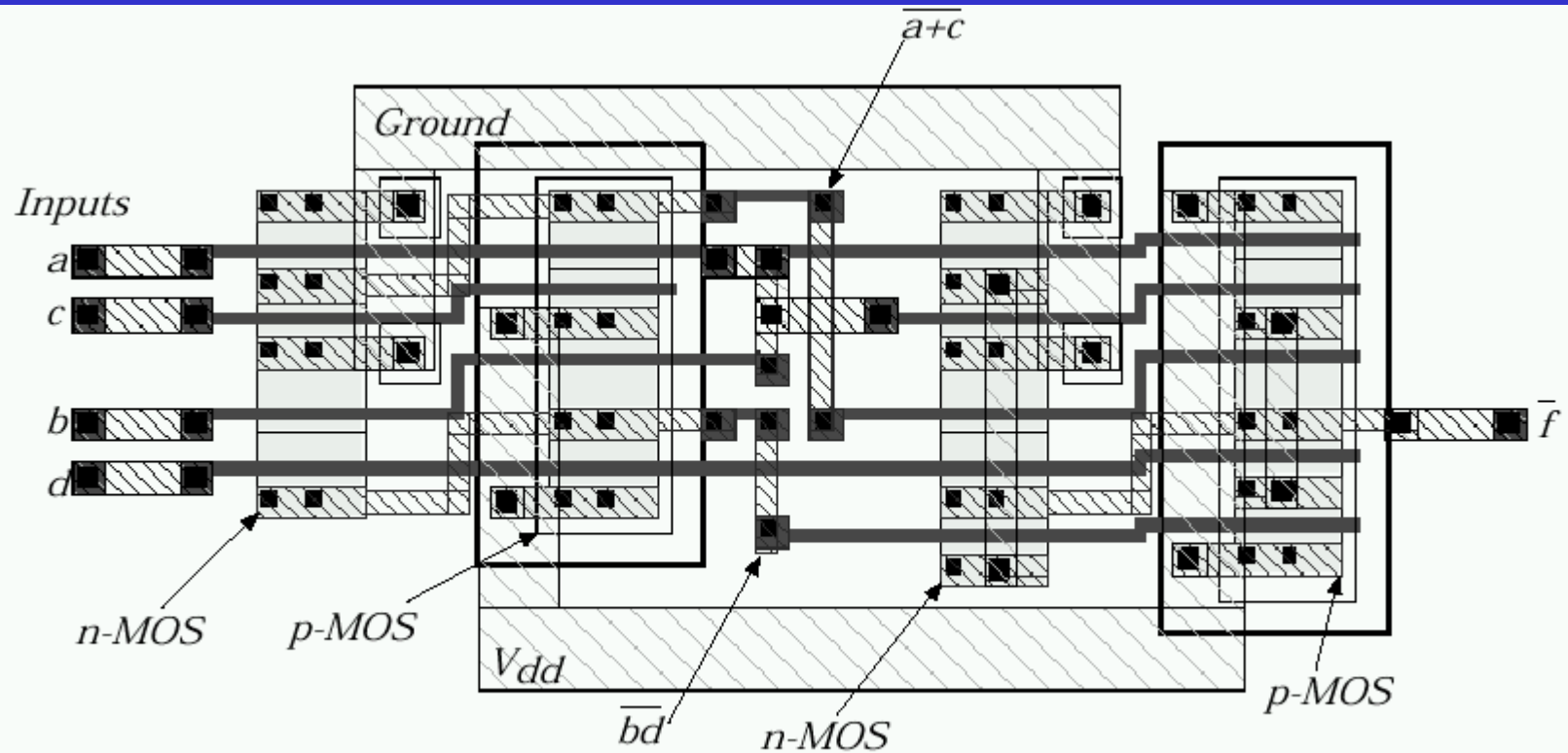

# Comparison of SIS and COMPLEX

function	SIS multi-level				COMPLEX			
	P1	P2	P5	Delay	P1	P2	P5	Delay
ch22f0	40	9	5	1.88	40	3	3	2.14
ch47f0	94	17	9	4.58	78	6	4	2.65
or_and_chain	28	6	7	2.05	22	4	5	1.75
substr1	54	10	6	2.06	46	6	5	2.04
parity(4 var)	52	10	5	1.90	66	7	5	2.33
ch30f0	66	12	7	3.62	58	5	5	2.63
ch74f1	120	20	10	4.66	82	8	5	3.07
modulus2	96	18	8	3.10	76	10	5	2.70
rnd_m10	148	27	9	3.25	160	21	7	3.68
pal	160	28	7	2.84	320	36	10	6.06

# Example of decomposition based synthesis for lattice diagrams.

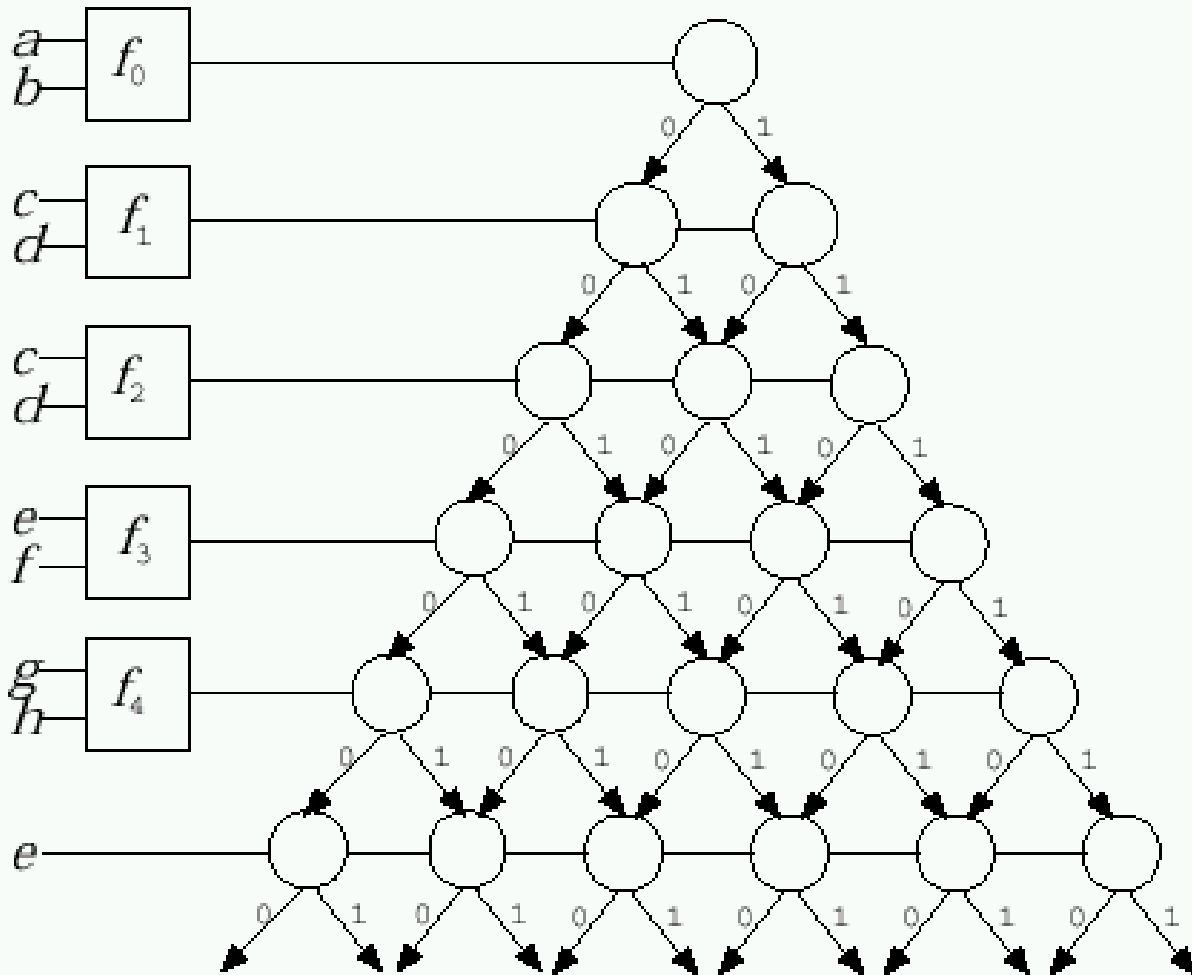

# Example of a application

**Synthesis for  
FPGAs**

# XILINX Field Programmable Gate Array

CONFIGURABLE  
INPUT/OUTPUT  
BLOCKS

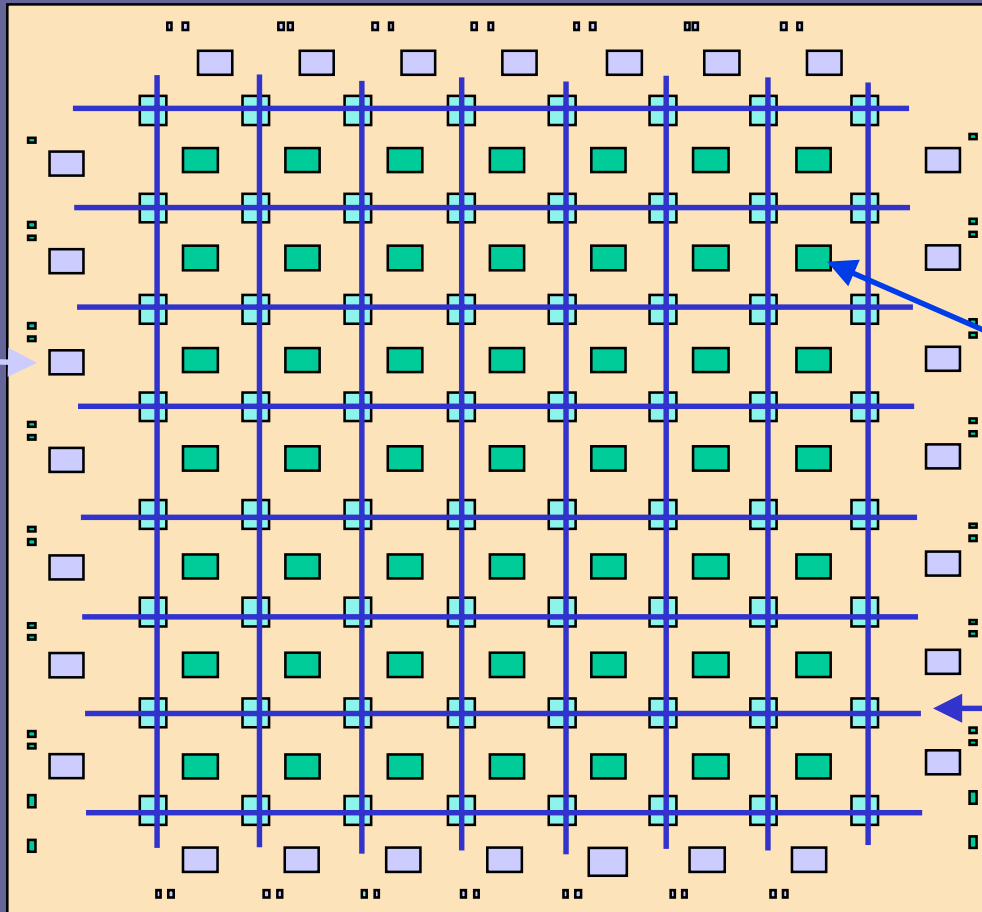

CONFIGURABLE  
LOGIC  
BLOCKS

CONFIGURABLE  
GLOBAL  
INTERCONNECTION

# Configurable Logic Block

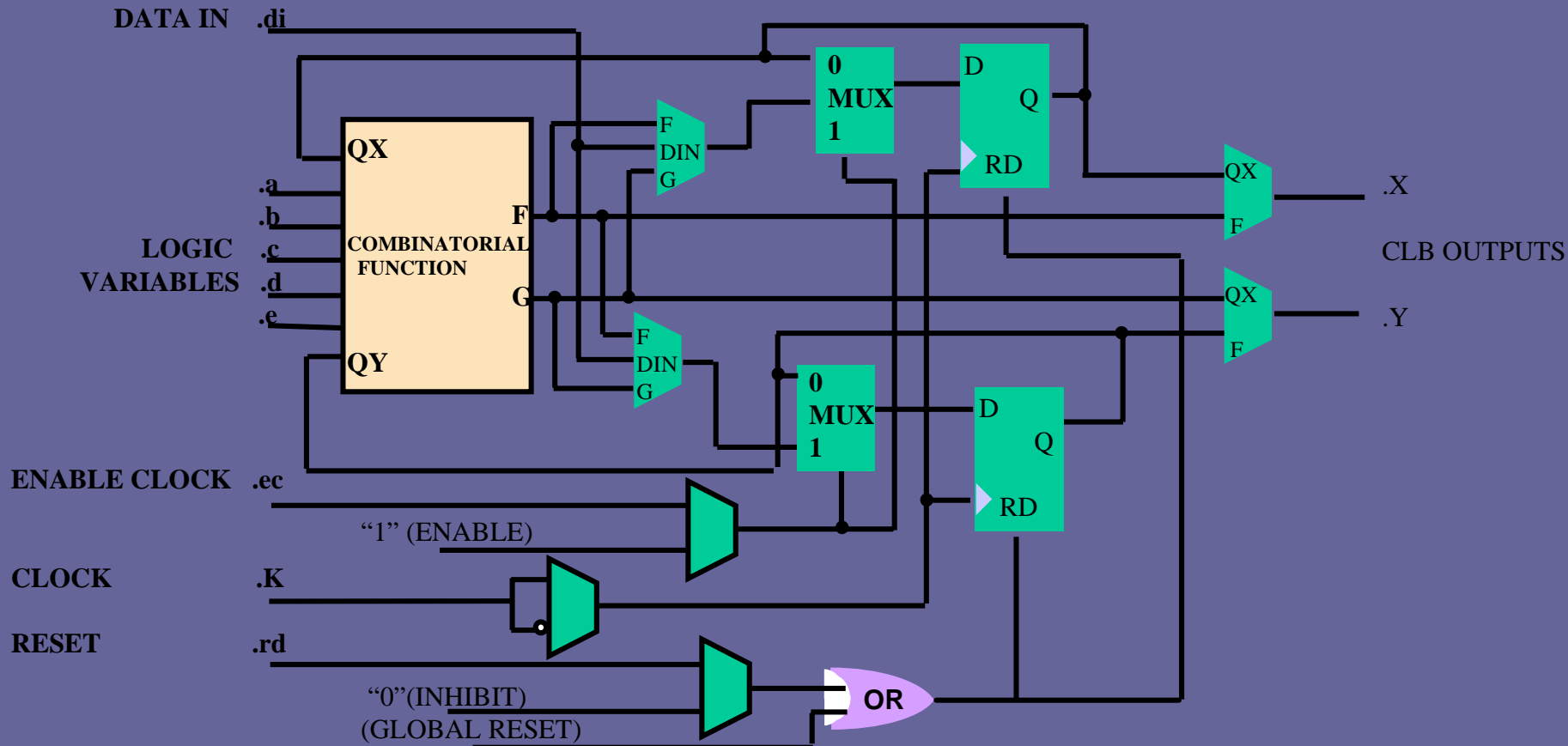



# Interconnections

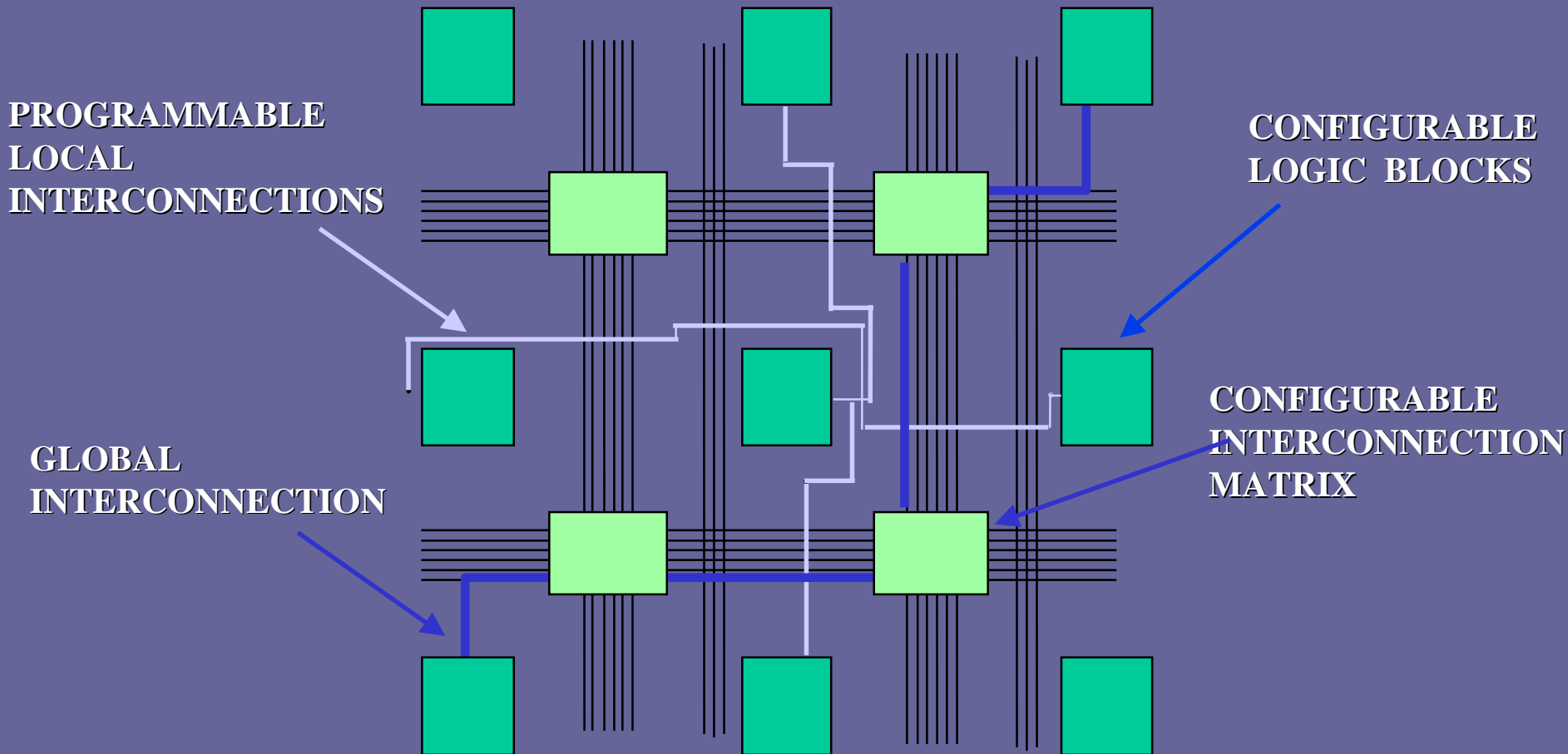

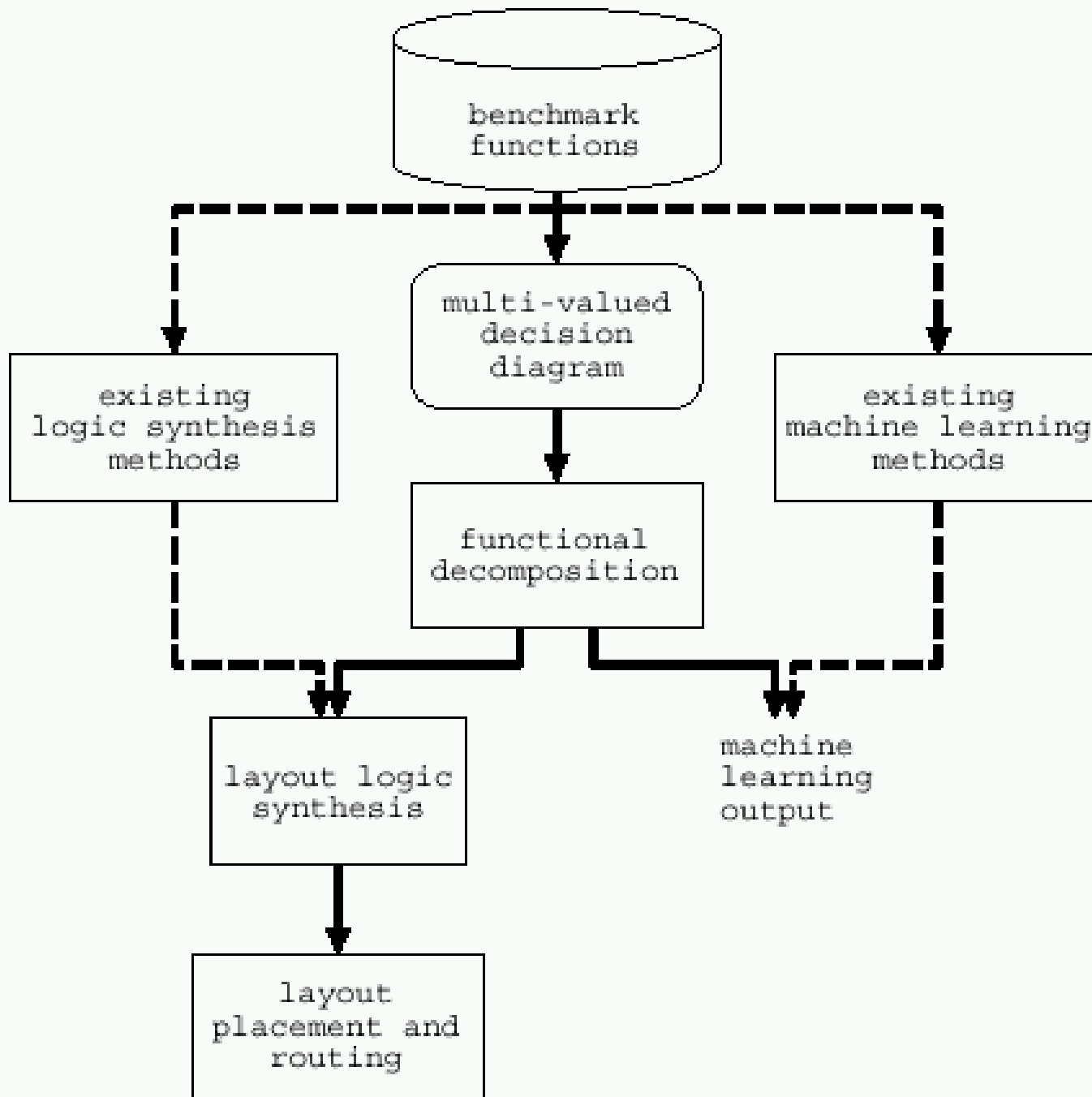





complete  
decomposition  
system.

# Example of a application

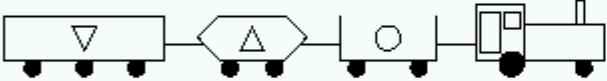

**Knowledge  
discovery in data  
with no error**

# Michalski's Trains

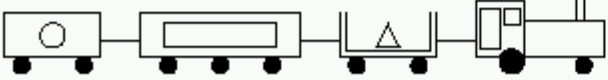
## 1. TRAINS GOING EAST

1. 
2. 
3. 
4. 
5. 

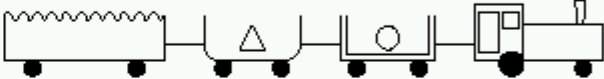
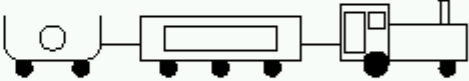
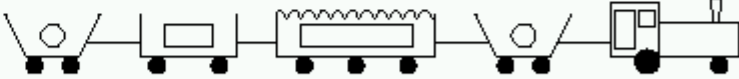
## 2. TRAINS GOING WEST

1. 
2. 
3. 
4. 
5. 

# Michalski's Trains

- Multiple-valued functions.
- There are 10 trains, five going East, five going West, and the problem is to find the simplest rule which, for a given train, would determine whether it is East or Westbound.
- The best rules discovered at that time were:
  - 1. If a train has a short closed car, then it Eastbound and otherwise Westbound.
  - 2. If a train has two cars, or has a car with a jagged roof then it is Westbound and otherwise Eastbound.
- Espresso format. MVGUD format.

# Michalski's Trains

```
.type mv
.i 32
.o 1
.ilb size load w0 l0 s0 n0 ls0 w1 l1 s1 n1 ls1 w2 l2 s2 n2 ls2 w3 l3 s3 n3 ls3
      a b c d e f g h i j
.ob direction
.imv 3 4 2 2 10 4 4 2 2 10 3 4 2 2 7 3 4 2 2 8 2 3 2 2 2 2 2 2 2 2 2
.omv 2
2 3 0 1 6 3 2 0 0 8 1 3 1 1 6 1 1 0 0 6 1 0 0 1 0 0 0 1 0 0 1 0 0
1 2 0 0 9 1 3 0 0 7 1 2 0 0 0 2 0 - - - - - 0 1 0 1 0 0 0 0 0 0 0 0
1 1 0 0 6 1 0 0 0 4 1 3 1 1 0 1 3 - - - - - 0 0 0 0 1 0 1 0 0 0 0 0
```

# Michalski's Trains

```
2 1 0 0 7 1 3 0 0 1 1 3 0 0 2 1 2 0 0 6 1 2 1 1 0 0 1 0 0 0 0 0 0
1 2 0 0 1 1 3 1 1 0 1 2 0 0 0 1 0 - - - - - 0 1 0 1 0 0 0 0 0 0 0
0 1 0 1 0 3 0 0 0 6 1 3 - - - - - - - - - - 0 0 0 0 0 0 1 0 0 0 1
1 1 0 0 1 1 0 0 0 9 1 3 0 1 5 0 - - - - - 0 0 0 0 0 0 1 0 0 0 1
0 1 1 1 0 1 2 0 0 9 1 0 - - - - - - - - - - 0 0 0 1 0 0 0 0 0 0 1
2 1 0 0 7 1 0 0 1 5 1 2 0 0 6 1 2 0 0 7 1 0 1 0 0 1 0 0 0 0 0 1
0 0 0 0 9 1 2 0 1 6 2 2 - - - - - - - - - - 1 0 0 0 0 0 0 0 0 0 1
.end
```

where:

- `.i` number of input variables (attributes)
- `.o` number of output variables (attributes)
- `.ilb` input variable names
- `.ob` output variable names
- `.imv` cardinalities of input variables
- `.omv` cardinalities of output variables

Variables 1-2: general attributes

- `size` number of cars (integer in [3-5])
- `load` number of different loads (integer in [1-4])

Variables 3-22: 5 attributes for each of cars 2 through 5: (20 attributes total)

- `w` number of wheels (integer in [2-3])
- `l` length (short or long)
- `s` shape (closedrect,dblopnrect,ellipse,engine,hexagon,jaggedtop,openrect,opentrap,slopetop,ushaped)
- `n` number of loads (integer in [0-3])
- `ls` load shape (circlelod,hexagonlod,rectanglod,trianglod)

Variables 23-32: 10 Boolean attributes describing whether 2 types of loads are on adjacent cars of the train

- `a` rectangle next to rectangle (0 if false, 1 if true)
- `b` rectangle next to triangle (0 if false, 1 if true)
- `c` rectangle next to hexagon (0 if false, 1 if true)
- `d` rectangle next to circle (0 if false, 1 if true)
- `e` triangle next to triangle (0 if false, 1 if true)
- `f` triangle next to hexagon (0 if false, 1 if true)
- `g` triangle next to circle (0 if false, 1 if true)
- `h` hexagon next to hexagon (0 if false, 1 if true)
- `i` hexagon next to circle (0 if false, 1 if true)
- `j` circle next to circle (0 if false, 1 if true)

# Michalski's Trains

- Attribute 33: Class attribute (east or west)
  - direction (east = 0, west = 1)
- The number of cars vary between 3 and 5. Therefore, attributes referring to properties of cars that do not exist (such as the 5 attributes for the "5th" car when the train has fewer than 5 cars) are assigned a value of "-".
- Applied to the trains problem our program discovered the following rules:
  - 1. If a train has triangle next to triangle or rectangle next to triangle on adjacent cars then it is Eastbound and otherwise Westbound.
  - 2. If the shape of car 1 (s1) is jagged top or open rectangle or u-shaped then it is Westbound and otherwise Eastbound.



# MV benchmarks: zoo

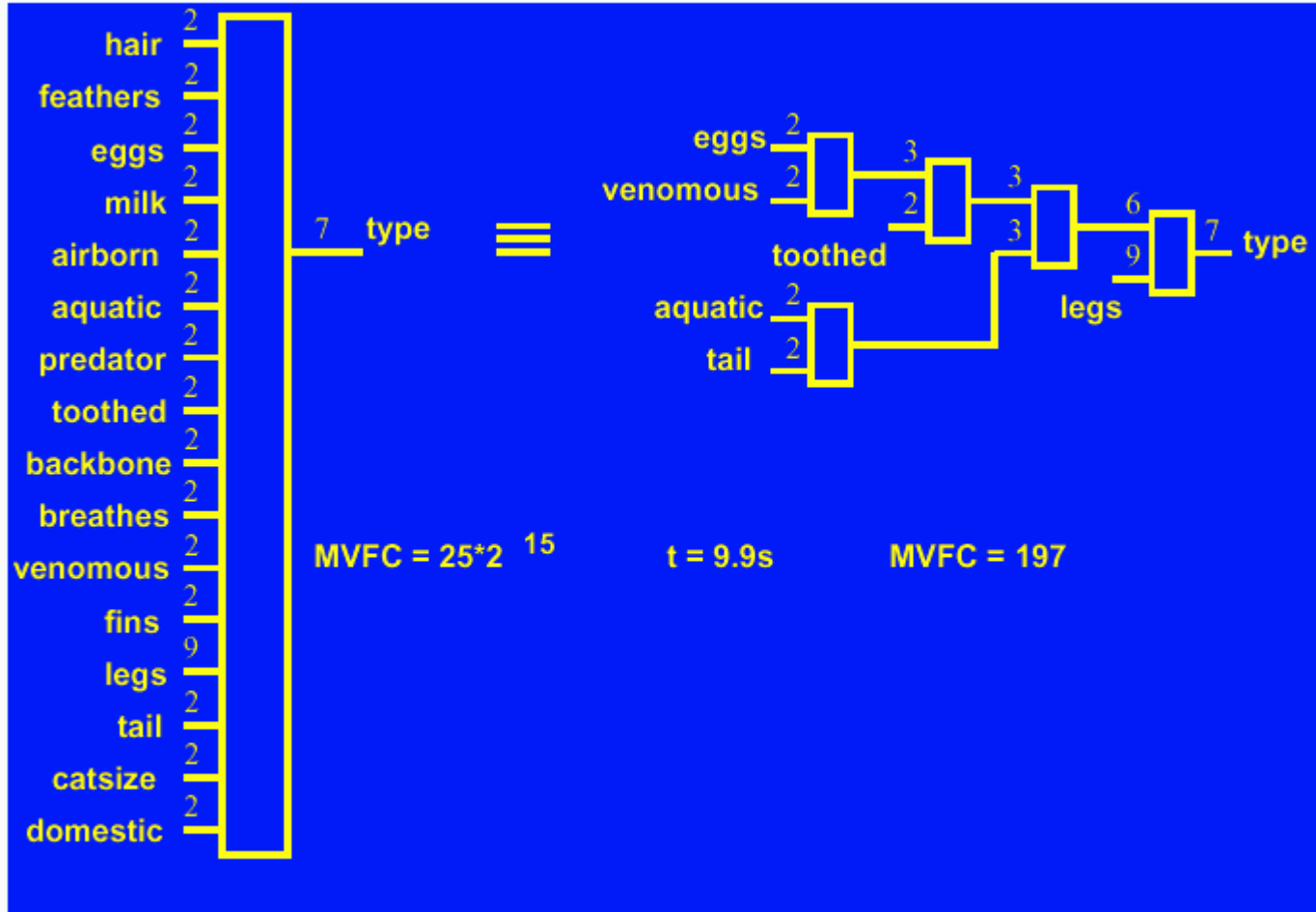

# MV benchmarks: shuttle

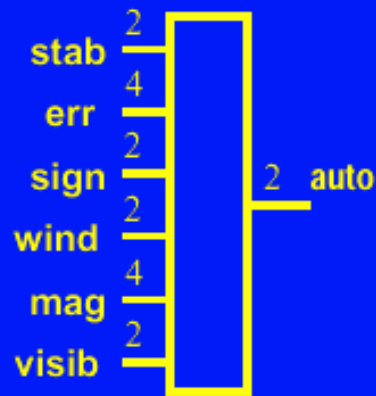

MVFC = 256

≡

t = 1.8s

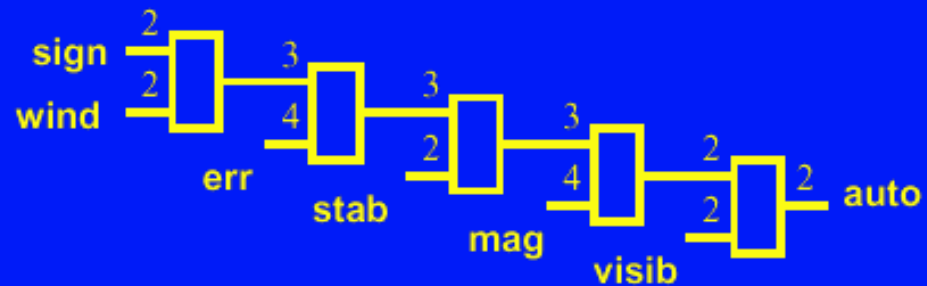

MVFC = 51

# MV benchmarks: lenses

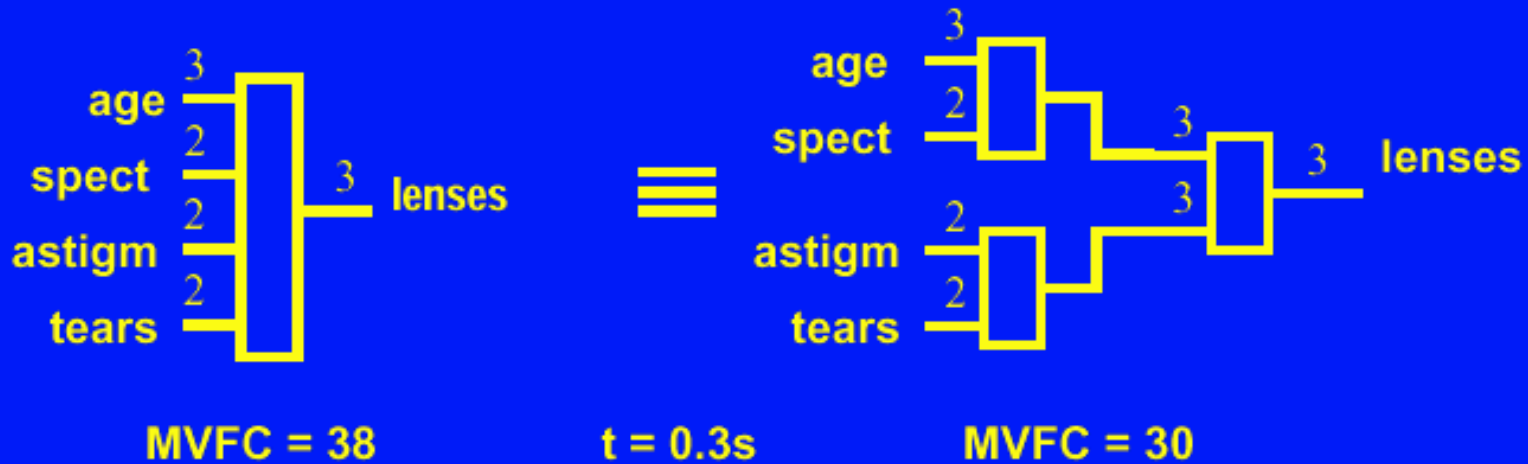

# Example of a application

**Medical data bases  
with error**

# Evaluation of results for learning

- 1. Learning Error

$$\text{error} = \frac{\text{\# of incorrectly classified samples}}{\text{total \# of samples}}$$

- 2. Occam Razor , complexity

# A machine learning approach versus several logic synthesis approaches

Original Function	Known DFC	Average Error			Number of Samples		
		C4.5	Decomp.	Espresso	C4.5	Decomp.	Espresso
kdd1	2	0	0	0	8	7	9
kdd2	8	0.32	0	0.96	31	25	40
kdd3	8	6.35	0	5.64	83	25	51
kdd4	12	2.48	3.72	2.64	74	67	76
kdd5	12	1.28	2.72	3.52	61	76	54
kdd6	16	2.76	2.4	12.86	97	126	113
kdd7	20	17.52	8.18	17.16	200	60	181
kdd8	20	13.79	6.55	16.54	224	104	205
kdd9	28	20.69	10.53	5.69	256	126	51
kdd10	36	10.52	11.11	8.44	249	251	229
Average		7.57	4.52	7.35	128.3	86.7	100.9

# Finding the error, DFC, and time of the decomposer on the benchmark **kdd5**.

Error

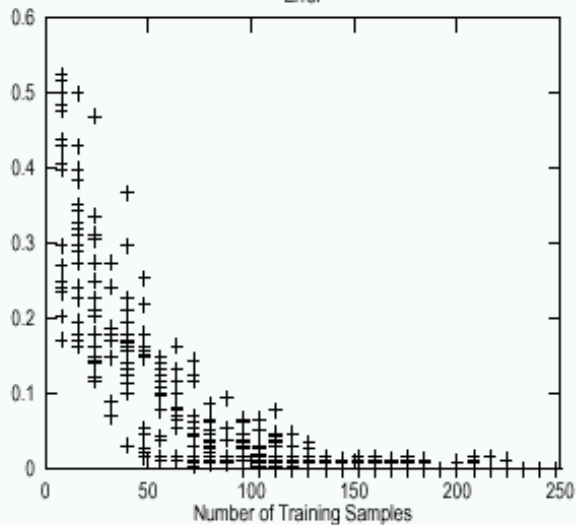

DFC

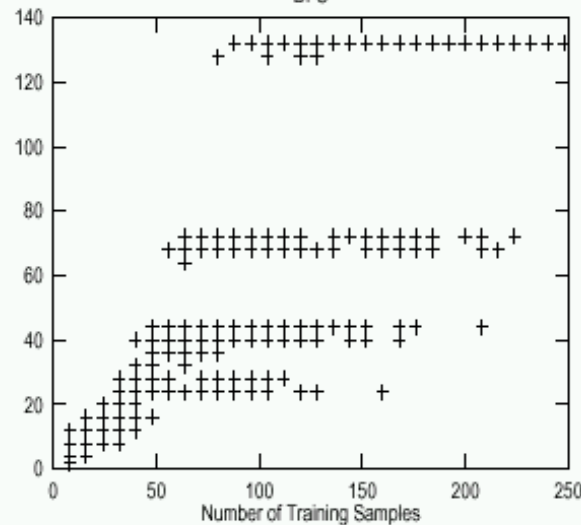

Time(sec)

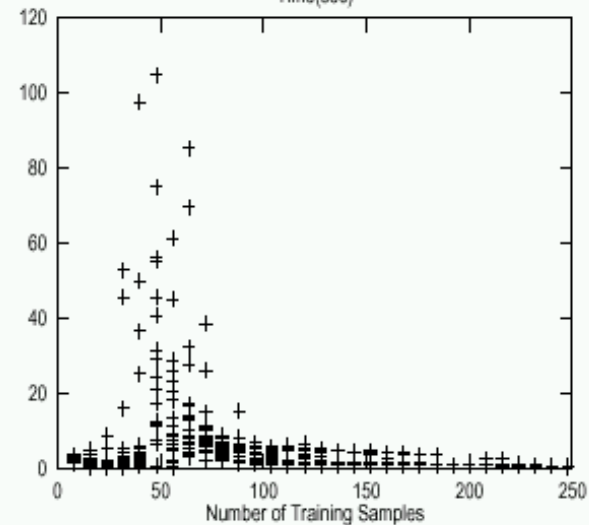

# The average error over 54 benchmark functions.

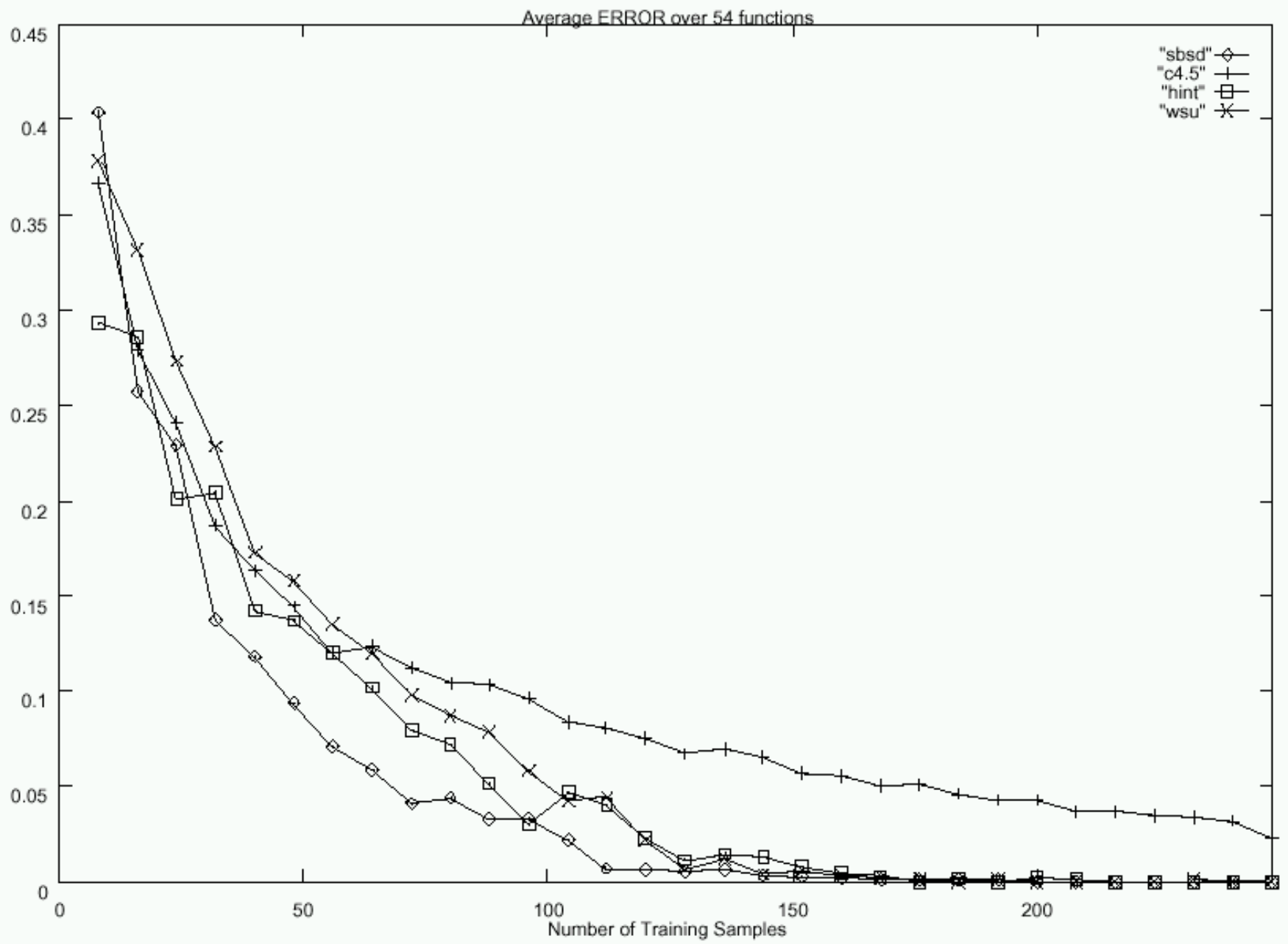



# MV benchmarks: breastc

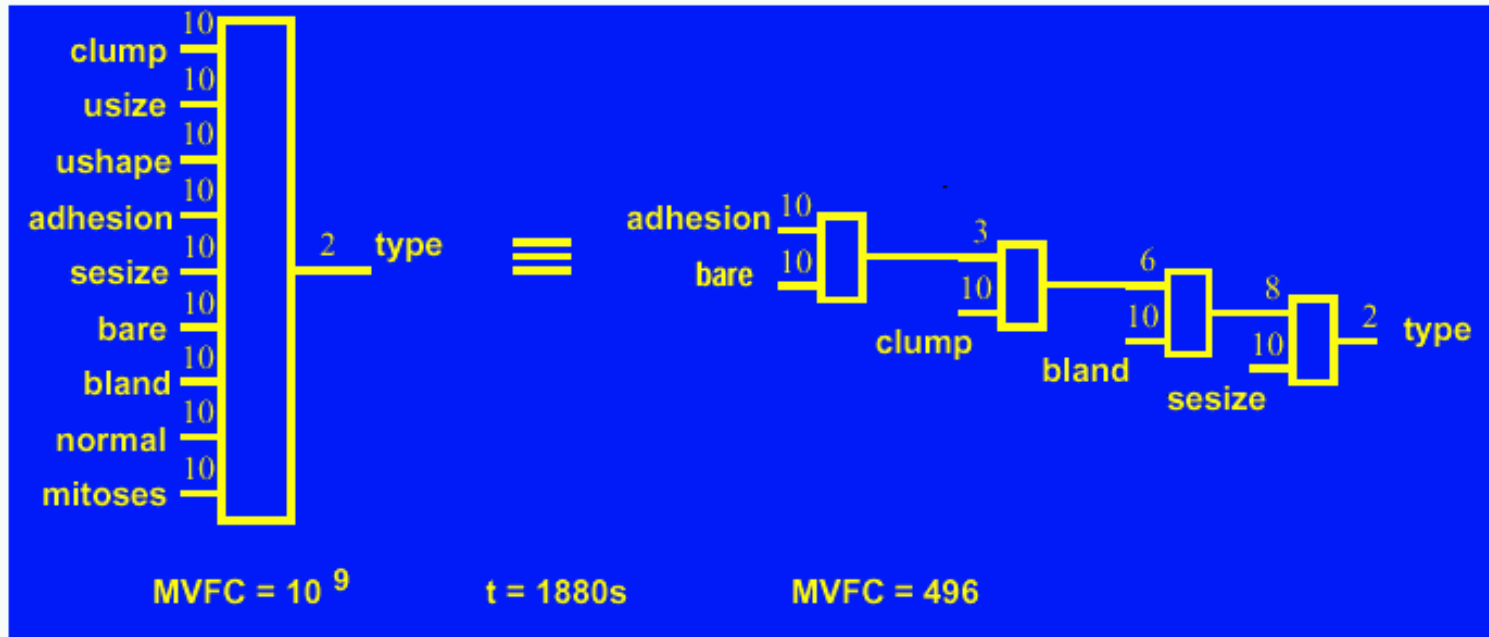

# Example of a application

**Data mining  
system for  
epidemiologists**

# Binning Strategy #1:

## Linear Mapping

Continuous Data

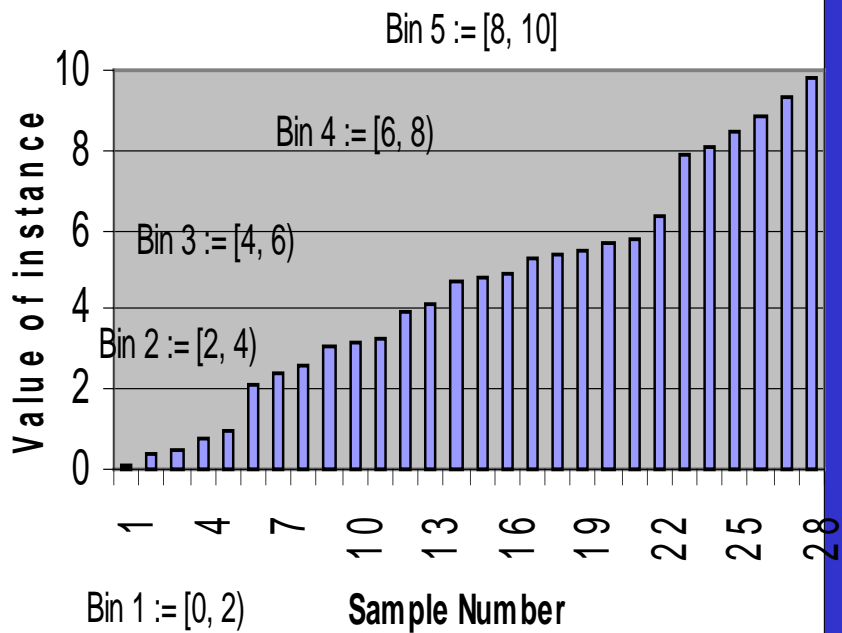

Discrete Data

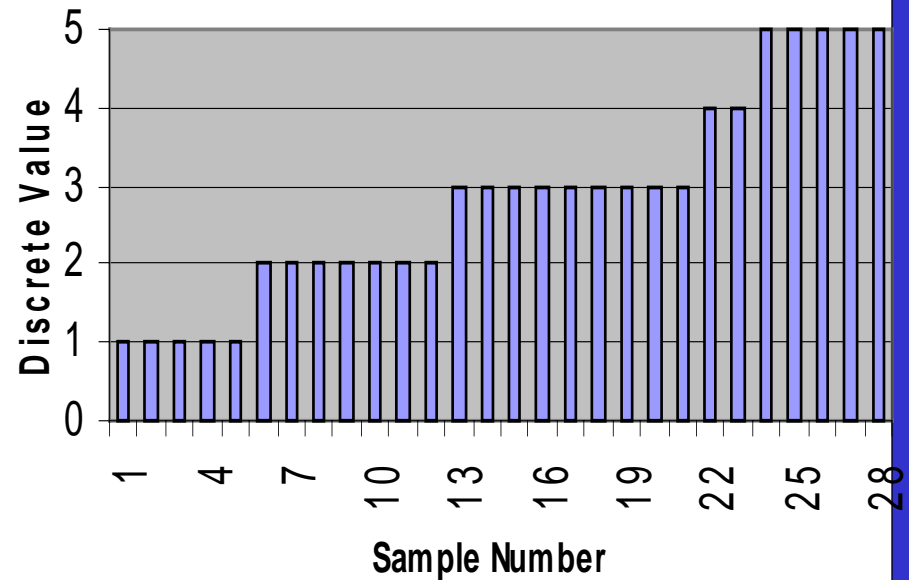

# Epidemiological Survey

Race:

\_\_\_\_\_ (W)      White  
\_\_\_\_\_ (B)      Black  
\_\_\_\_\_ (O)      Other

Did you [Name of child] have contact with or change any diapers while at Battleground State Park?

\_\_\_\_\_ (1) YES    \_\_\_\_\_ (2) NO    \_\_\_\_\_ (9) DK

Estimate the amount of time you [Name of child] spent in the water (total time):

> 2 hours                      \_\_\_\_\_ (3)  
15 minutes – 2 hours        \_\_\_\_\_ (2)  
< 15 minutes                    \_\_\_\_\_ (1)

How serious was your child's illness?

\_\_\_\_\_ (1) No illness    \_\_\_\_\_ (2) diarrhea but no fever    \_\_\_\_\_ (3) diarrhea and fever    \_\_\_\_\_ (9) DK

# Survey Encoding

## Input Variable 'a'

White encodes to '0'  
Black encodes to '1'  
Other encodes to '2'

## Input Variable 'b'

DK encodes to '2'  
NO encodes to '1'  
YES encodes to '0'

## Input Variable 'c'

2 hr < encodes to '2'  
[.25, 2) hr encodes to '1'  
< .25 hr encodes to '0'

## Output Variable 'z'

Don't Know encodes to '3'  
Diarrhea and fever encodes to '2'  
Diarrhea but no fever encodes to '1'  
No illness encodes to '0'

# Survey Data: Sample 0

Race:

(W) White  
 (B) Black  
 (O) Other

Did you [Name of child] have contact with or change any diapers while at Battleground State Park?

(1) YES  (2) NO  (9) DK

Estimate the amount of time you [Name of child] spent in the water (total time):

> 2 hours  (3)  
15 minutes – 2 hours  (2)  
< 15 minutes  (1)

How serious was your child's illness?

(1) No illness  (2) diarrhea but no fever  (3) diarrhea and fever  (9) DK

# Encoded Survey Data: Sample 0

<b>Sample #</b>	<b>a</b>	<b>b</b>	<b>c</b>	<b>f</b>
<b>0</b>	<b>1</b>	<b>0</b>	<b>2</b>	<b>2</b>

# Ten Encoded Surveys

S a m p l e #	a	b	c	z
0	1	0	2	2
1	2	1	2	0
2	2	2	1	3
3	0	2	1	1
4	2	1	2	0
5	2	2	1	2
6	0	2	1	0
7	0	2	0	1
8	1	1	2	2
9	1	1	1	0

**Multi-valued Relation Represented Tabular Form**



# Market

- **Current intended market**
- State and federal epidemiologists working within the United States of America.
- **Anticipated market demand**
- There are approximately 1000 epidemiologists in the United States.
- **Predicable future markets**
- Any application where there is a data set with many unknown values and a user that wishes to generate hypothesis from the data.

# Competition

- **Oracle's Darwin®**
  - Darwin's one-click data import wizards accept data in all popular formats, including ODBC, ASCII, and SAS
  - Array of techniques increases modeling accuracy. These techniques include regression trees, neural networks, *k*-nearest neighbors, regression, and clustering algorithms
- **Wizsoft's WizRule**
  - Reports the rules, and the cases deviating from the norm
  - Sorts the deviated cases by their level of unlikelihood
- **Information Discovery's Data Mining Suite**
  - Uses relational and multi-dimensional data
  - Results are delivered to the user in plain English, accompanied by tables and graph that highlight the key patterns
- **Center for Disease Control's Epi Info**
  - Tailored for Epidemiologist
  - DOS based suite of Application

# Flow of the Program

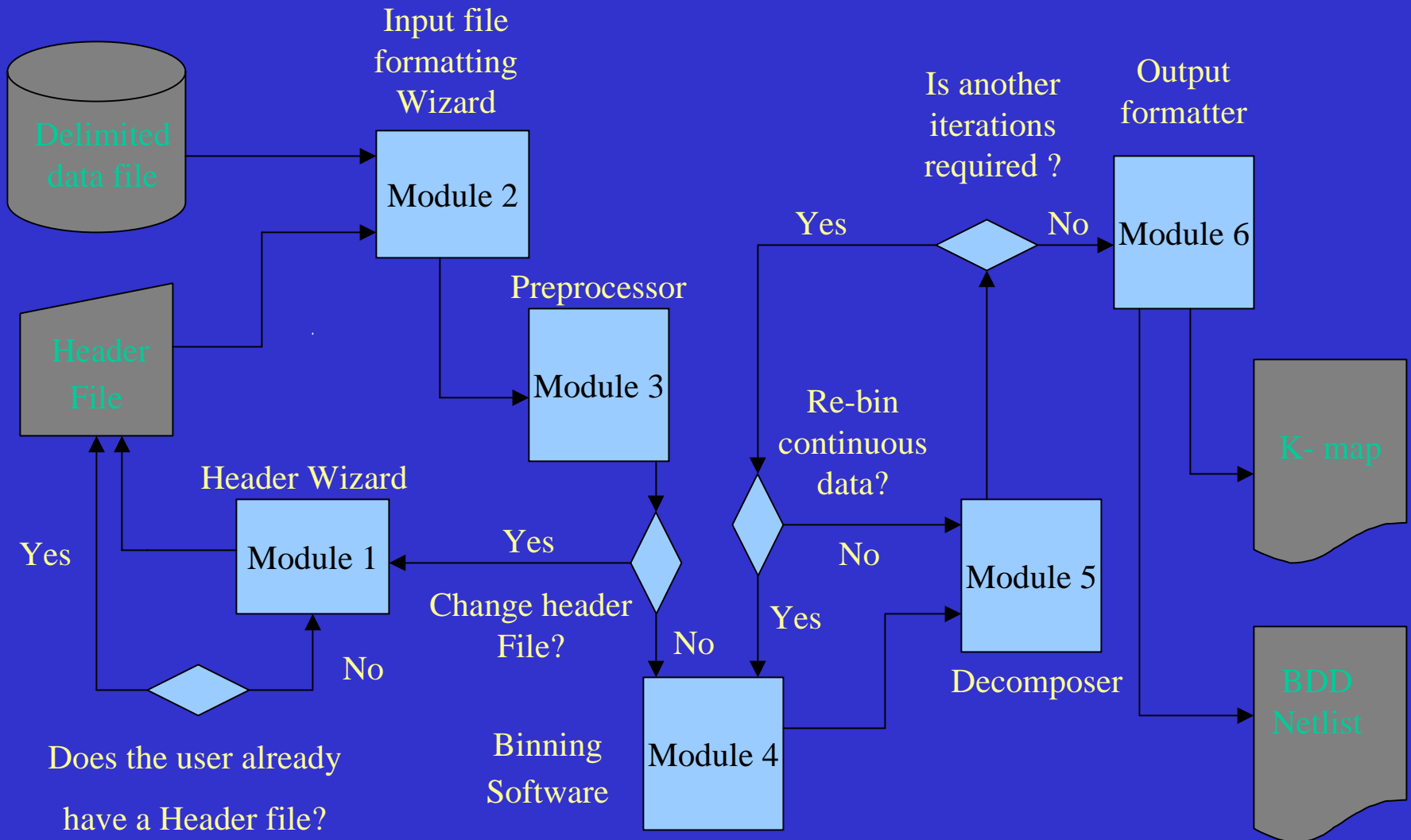

# Example of a application

**Gait control of a robot  
puppet for Oregon  
Cyber Theatre**



# Model with a gripper

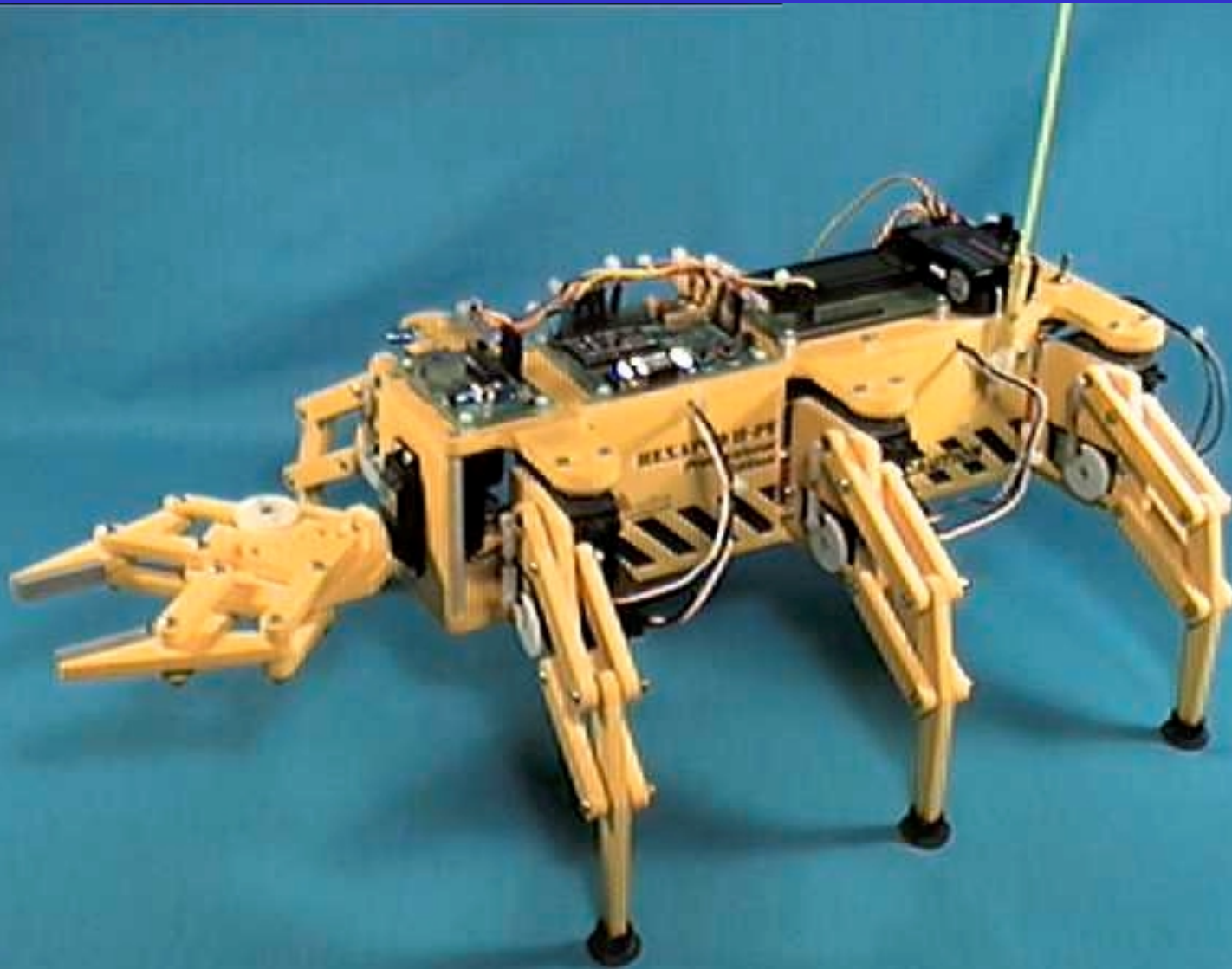

# Model with an internet camera

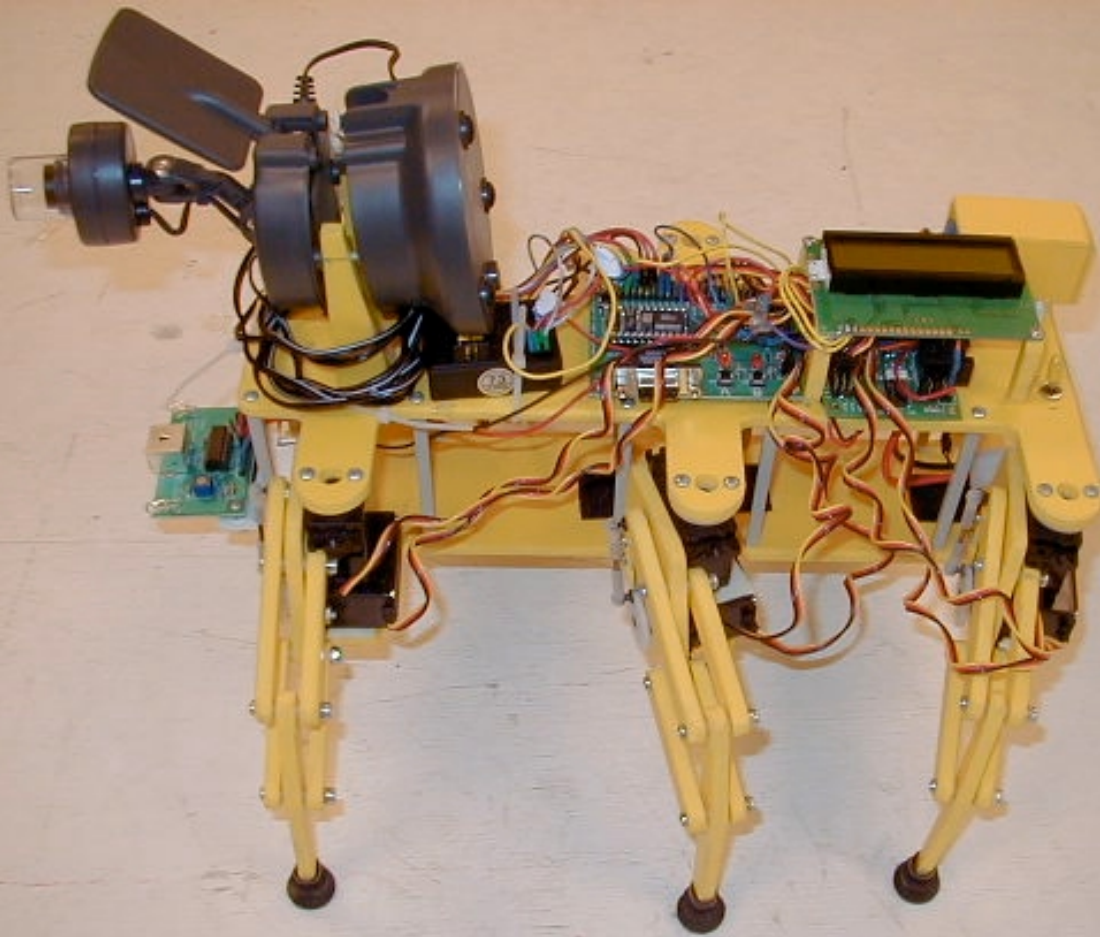

# Spider I control - phase five: *supercomputer*

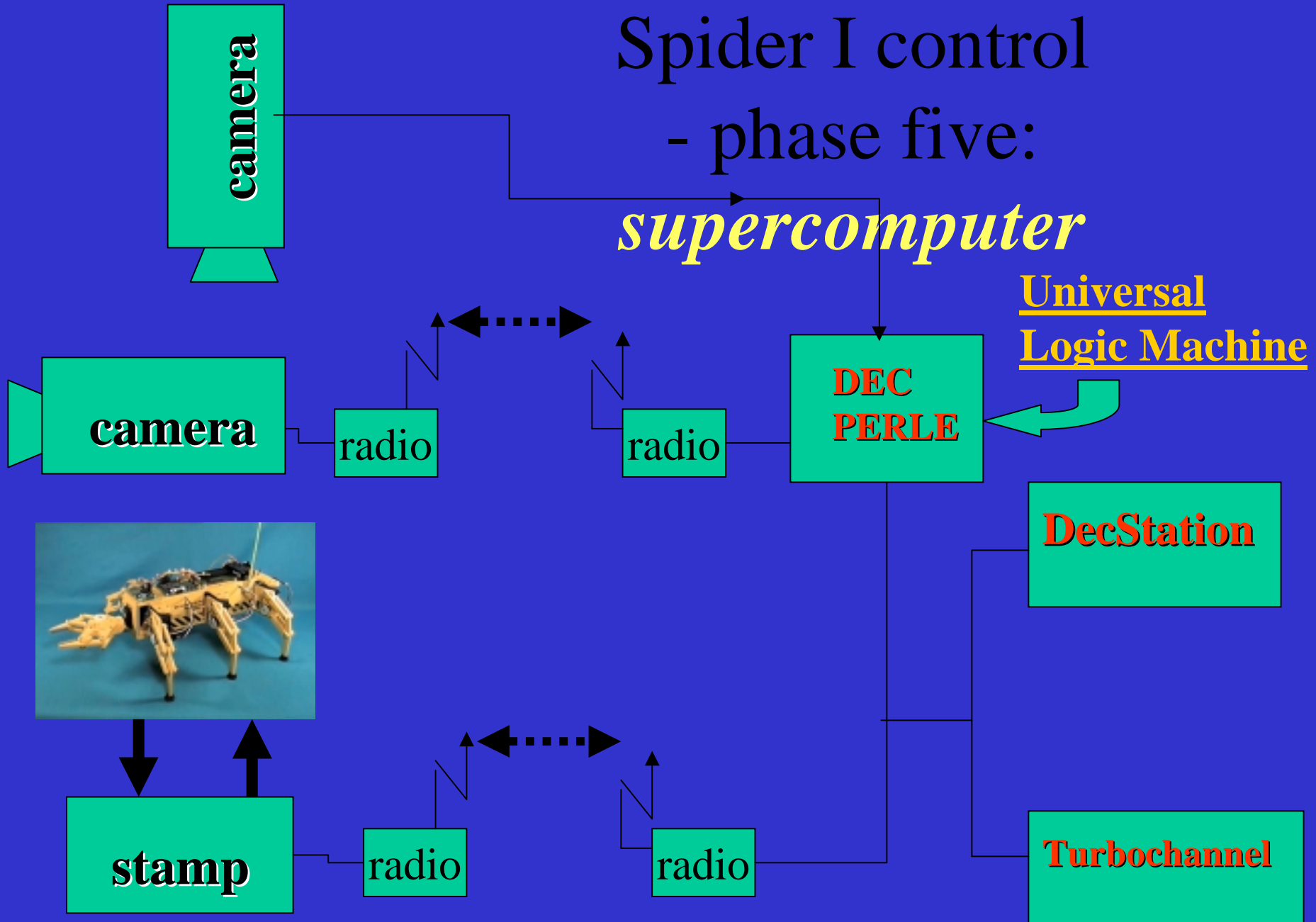



# teaching a hexapod to walk



- The following formula describes the exact motion of the shaft of every servo.

$$\theta_i(t) = \theta_o + A_i \sin(\omega_i * t + \phi_i)$$

- Theta, the angle of the servo's shaft, is a function of time.
- Theta naught is a base value corresponding to the servo's middle position. Theta naught will be the same for all the servos.
- 'A' is called the amplitude of the oscillation. It relates to how many degrees the shaft is able to rotate through.
- Omega relates to how fast the servo's shaft rotates back and forth. Currently, for all servos, there are only four possible value that omega may take
- Phi is the relative phase angle.

# And a familiar table again

Trial	Inputs							Outputs		
	Servo 1			...	Servo 12			x	y	z
	Amp	Freq	Phase	...	Amp	Freq	Phase			
1	0	1	4	...	1	1	2	-1	1	0
...	...	...	...	...	...	...	...	...	...	...
n	1	1	5	...	1	0	0	-1	-1	1

# Conclusion

- Stimulated by practical hard problems:
  - Field Programmable Gate Arrays (FPGA),
  - Application Specific Integrated Circuits (ASIC)
  - high performance custom design (Intel)
  - Very Large Scale of Integration (VLSI) layout-driven synthesis for custom processors,
  - robotics (hexapod gaits, face recognition),
  - Machine Learning,
  - Data Mining.

# Conclusion

- Developed 1989-present
- Intel, Washington County epidemiology office, Northwest Family Planning Services, Lattice Logic Corporation, Cypress Semiconductor, AbTech Corp., Air Force Office of Scientific Research, Wright Laboratories.
- A set of tools for decomposition of binary and multi-valued functions and relations.
- Extended to fuzzy logic, reconstructability analysis and real-valued functions.

# Conclusion

- Our recent software allows also for bi-decomposition, removal of vacuous variables and other preprocessing/postprocessing operations.
- Variants of our software are used in several commercial companies.
- The applications of the method are unlimited and it can be used whenever decision trees or artificial neural nets are used now.
- The quality of learning was better than in the top decision tree creating program C4.5 and various neural nets.
- The only problem that remains is speed in some applications.

# Conclusion

- **On our WWW page,**

[http:// www.ee.pdx.edu/~cfiles/papers.html](http://www.ee.pdx.edu/~cfiles/papers.html)

the reader can find many benchmarks from various disciplines that can be used for comparison of machine learning and logic synthesis programs.

- We plan to continue work on decomposition and its various practical applications such as epidemiology or robotics which generate large real-life benchmarks.
- We work on FPGA-based reconfigurable hardware accelerator for decomposition to be used on a mobile robot.